

Tapones y Capuchones

Plugs & Caps

Bouchons & Capuchons

Stopfen & Kappen

Zatyczki i Nakładki

MTO-MTOZ Tapón paralelo acabado

Locking hole plug

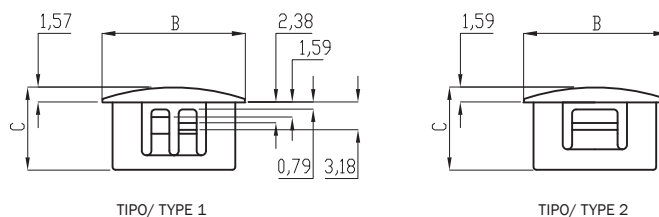

Material: PA66

Referencia Reference	A. Panel H. Diameter	G. Panel P. Thickness	B	C	Tipo Type
00100700037	4,80	1,60	6,40	5,90	2
00100700101	4,80	1,60	6,40	5,90	2
00100700038	6,40	1,60	8,00	8,00	2
00100700103	8,00	1,60	9,50	5,90	2
00100700039	8,00	1,60	9,50	8,00	2
00100700040	9,50	3,20	12,00	10,30	1
00100700041	11,00	3,20	13,50	10,30	1
00100700104	12,70	1,60	14,60	6,35	2
00100700042	12,70	3,20	14,60	10,30	1
00100700043	14,30	3,20	16,70	10,30	1
00100700105	15,90	1,60	18,20	6,35	2
00100700044	15,90	3,20	18,20	10,30	1
00100700045	17,50	3,20	20,00	10,30	1
00100700106	19,00	1,60	23,20	6,35	2

Referencia Reference	A. Panel H. Diameter	G. Panel P. Thickness	B	C	Tipo Type
00100700046	19,00	3,20	23,20	10,30	1
00100700047	20,60	3,20	22,60	10,30	1
00100700107	22,20	1,60	25,80	6,35	2
00100700048	22,20	3,20	25,80	11,50	1
00100700049	25,50	3,20	30,50	11,50	1
00100700050	28,00 - 28,50	3,20	31,00	11,50	1
00100700051	30,10	3,20	33,30	11,50	1
00100700052	32,00	3,20	34,90	11,50	1
00100700100	32,00	3,20	38,00	11,50	1
00100700053	35,00	3,20	38,00	11,50	1
00100700054	38,00	3,20	42,70	11,50	1
00100700055	45,00	3,20	48,90	11,50	1
00100700056	51,00	3,20	55,00	11,50	1
00100700057	63,50	6,40	70,50	19,10	1

Color: Negro / Blanco / Gris - Black / White / Grey

MTOV Tapón paralelo ventilación

Locking vent plug

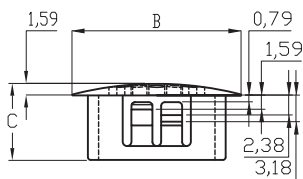

Material: PA66

Referencia Reference	A. Panel H. Diameter	Máx G. Panel Max P. Thickness	B	C
00100700058	19,10	3,20	23,00	10,30
00100700059	22,50	3,20	25,80	11,50
00100700060	25,50	3,20	30,50	11,50

Color: Negro / Blanco - Black / White

MTOTA Tapón paralelo transparente

Window plug

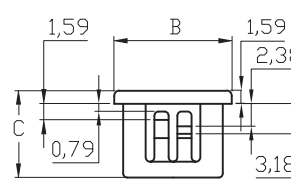

Material: PETG

Referencia Reference	A. Panel H. Diameter	Máx G. Panel Max P. Thickness	B	C
00100700110	4,80	1,60	6,40	5,90
00100700111	6,40	1,60	8,00	8,00
00100700112	8,00	1,60	9,50	8,00
00100700113	9,50	3,20	12,00	10,30
00100700114	11,00	3,20	13,50	10,30
00100700115	12,70	3,20	14,60	10,30
00100700116	15,90	3,20	18,20	10,30

Color: Transparente - Transparent

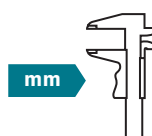

LB Tapón acabado
Finish end plug



Material: LDPE RoHS

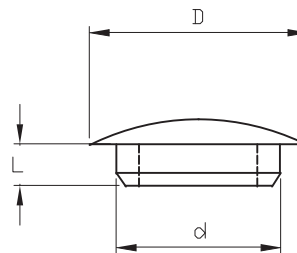

Tapones y
Capuchones
Plugs & Caps

Referencia Reference	A. Panel (d) H. Diameter (d)	D	L
00300700120	2,50	10,00	5,00
00300700121	2,50	12,00	5,00
00300700122	2,50	15,00	5,00
00300700123	2,80	5,80	5,00
00300700124	2,80	11,00	4,80
00300700125	3,00	12,00	6,00
00300700126	3,00	15,00	6,00
00300700127	3,00	18,00	7,00
00300700128	4,00	6,40	5,30
00300700230	4,00	8,00	3,00
00300700231	4,00	10,00	5,30
00300700232	4,00	13,00	5,30
00300700233	4,10	8,00	7,00
00300700129	5,00	6,60	5,50
00300700130	5,00	8,00	5,00
00300700234	5,00	8,00	5,50
00300700131	5,00	10,00	5,50
00300700235	5,00	13,00	4,00
00300700132	5,00	13,00	5,50
00300700133	5,00	15,00	5,50
00300700208	5,00	20,00	7,50
00300700236	5,20	13,00	7,00
00300700134	5,40	8,00	7,40
00300700135	5,40	10,00	7,40
00300700136	5,40	13,00	7,40
00300700137	5,40	15,00	7,40
00300700138	5,50	8,00	5,80
00300700237	5,50	10,00	5,60
00300700238	5,50	12,00	5,60
00300700139	6,00	8,00	5,40
00300700140	6,00	10,00	5,40
00300700239	6,00	12,00	7,00
00300700141	6,00	13,00	5,40
00300700142	6,00	15,00	5,40
00300700143	6,50	13,00	6,00
00300700144	6,50	15,00	6,00
00300700240	6,60	13,00	7,00
00300700241	6,60	15,00	7,00
00300700242	7,00	10,00	3,90
00300700145	7,00	10,00	6,50
00300700146	7,00	13,00	6,50
00300700147	7,00	15,00	6,50
00300700148	7,00	16,00	3,90
00300700243	7,00	20,00	7,50

Referencia Reference	A. Panel (d) H. Diameter (d)	D	L
00300700244	7,20	10,00	2,00
00300700245	7,90	13,00	6,00
00300700149	8,00	10,00	6,30
00300700150	8,00	13,00	6,30
00300700151	8,00	15,00	6,30
00300700152	8,00	16,00	6,30
00300700246	8,00	17,00	6,30
00300700153	8,50	13,00	6,90
00300700154	8,50	15,00	6,90
00300700155	8,50	16,00	6,90
00300700247	9,00	12,00	6,40
00300700156	9,00	13,00	6,40
00300700157	9,00	15,00	6,40
00300700158	9,00	16,00	6,40
00300700248	10,00	12,00	6,70
00300700249	10,00	13,00	3,00
00300700159	10,00	13,00	6,70
00300700160	10,00	15,00	6,70
00300700161	10,00	16,00	6,70
00300700162	10,50	13,00	4,00
00300700163	11,00	13,00	5,00
00300700164	11,00	15,00	5,00
00300700165	11,00	16,00	5,00
00300700166	12,00	15,00	8,40
00300700250	12,00	15,00	11,60
00300700167	12,00	18,00	7,00
00300700168	13,00	16,00	8,50
00300700169	13,00	17,00	8,50
00300700170	14,00	18,00	7,00
00300700209	15,00	17,00	3,00
00300700171	15,00	17,00	9,00
00300700210	15,00	18,00	1,40
00300700251	15,00	19,00	3,00
00300700172	15,00	19,00	9,00
00300700252	15,00	20,00	3,00
00300700173	15,00	20,00	4,00
00300700174	15,50	19,00	4,50
00300700175	17,00	24,50	6,00
00300700253	18,30	28,00	6,00
00300700255	20,00	23,00	3,00
00300700176	20,00	23,00	10,00
00300700254	20,40	28,00	4,80
00300700256	20,80	28,00	4,80
00300700177	25,00	30,00	5,00

Color: Negro / Blanco / Gris - Black / White / Grey



mm



LCF Tapón universal Universal plug

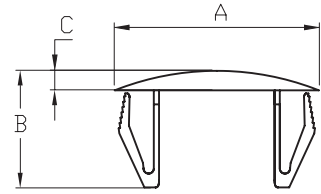

Material: POM UL94 V2/V0

Referencia Reference	Agujero Panel Hole Diameter	Grosor Panel Panel Thickness	A	B	C
00300700500	9,50 - 11,00	0,80 - 3,20	16,00	12,60	1,60
00300700501	12,70 - 14,30	0,80 - 3,20	18,50	12,00	1,60
00300700502	18,40 - 20,60	0,80 - 3,20	25,00	12,00	1,60
00300700503	35,00 - 38,00	0,80 - 3,20	43,00	13,20	1,60
00300700504	45,00 - 47,50	0,80 - 3,20	52,00	13,20	1,60

Color: Negro - Black

MT Tapón paralelo Hole plug

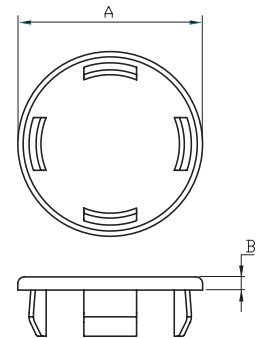

Material: PA66 UL94 V2/V0

Referencia Reference	A. Panel H. Diameter	G. Panel P. Thickness	A	B	Acabado Finishing	Tipo cabeza Head type	Métrica Metric
00100700008	3,18	0,79 - 2,39	5,16	1,02	Brillante/Glossy	Plana/Flat	
00100700009	3,81	0,79 - 2,39	6,35	1,02	Brillante/Glossy	Plana/Flat	
00100700001B	4,75	0,79 - 3,56	8,74	1,02	Brillante/Glossy	Plana/Flat	
00100700001M	4,75	0,79 - 3,56	8,74	1,02	Mate/Matte	Plana/Flat	
00100700003	5,54	0,79 - 1,58	9,53	6,35	Brillante/Glossy	Seta/Mushroom	
00100700034	5,54	0,79 - 2,39	9,53	6,35	Brillante/Glossy	Seta/Mushroom	
00100700089	6,00	0,80 - 1,60	10,00	2,00	Mate/Matte	Plana/Flat	M6
00100700004B	6,35	0,79 - 1,58	10,72	1,02	Brillante/Glossy	Plana/Flat	
00100700004M	6,35	0,79 - 1,58	10,72	1,02	Mate/Matte	Plana/Flat	
00100700006B	7,93	0,79 - 3,56	11,51	1,40	Brillante/Glossy	Plana/Flat	
00100700006M	7,93	0,79 - 3,56	11,51	1,40	Mate/Matte	Plana/Flat	
00100700090	8,00	0,80 - 3,50	12,00	2,00	Mate/Matte	Plana/Flat	M8
00100700011	9,53	0,79 - 3,56	14,68	1,27	Brillante/Glossy	Plana/Flat	
00100700012	9,53	0,79 - 3,56	14,68	1,40	Mate/Matte	Plana/Flat	
00100700010	9,53	0,79 - 3,56	17,07	1,58	Brillante/Glossy	Plana/Flat	
00100700091	10,00	0,80 - 3,50	14,00	2,00	Mate/Matte	Plana/Flat	M10
00100700014	11,10	0,79 - 4,34	15,47	1,27	Mate/Matte	Plana/Flat	
00100700013	11,10	0,79 - 4,34	15,47	1,40	Brillante/Glossy	Plana/Flat	

Color: Natural / Negro - Natural / Black

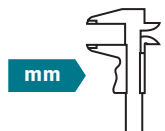

Referencia Reference	A. Panel H. Diameter	G. Panel P. Thickness	A	B	Acabado Finishing	Tipo cabeza Head type	Métrica Metric
00100700092	12,00	0,80 - 3,50	16,00	2,00	Mate/Matte	Plana/Flat	M12
00100700015	12,19	0,79 - 0,99	14,68	1,27	Mate/Matte	Plana/Flat	
00100700016B	12,70	0,79 - 3,56	17,07	1,58	Brillante/Glossy	Plana/Flat	
00100700016M	12,70	0,79 - 3,56	17,07	1,58	Mate/Matte	Plana/Flat	
00100700093	14,00	0,80 - 3,50	18,00	2,00	Mate/Matte	Seta/Mushroom	M14
00100700018B	14,28	0,79 - 3,56	18,64	1,58	Brillante/Glossy	Seta/Mushroom	
00100700018M	14,28	0,79 - 3,56	18,64	1,58	Mate/Matte	Plana/Flat	
00100700020B	15,88	0,79 - 1,83	20,24	1,58	Brillante/Glossy	Plana/Flat	
00100700020M	15,88	0,79 - 1,83	20,24	1,58	Mate/Matte	Plana/Flat	
00100700094	16,00	0,80 - 3,50	20,00	2,00	Mate/Matte	Plana/Flat	M16
00100700022B	17,45	0,79 - 2,77	22,63	1,58	Brillante/Glossy	Plana/Flat	
00100700022M	17,45	0,79 - 2,77	22,63	1,58	Mate/Matte	Plana/Flat	
00100700095	18,00	0,80 - 4,00	22,00	2,00	Mate/Matte	Plana/Flat	M18
00100700024B	19,05	0,79 - 2,77	25,00	1,58	Brillante/Glossy	Plana/Flat	
00100700024M	19,05	0,79 - 2,77	25,00	1,58	Mate/Matte	Plana/Flat	
00100700096	20,00	0,80 - 4,00	26,00	2,00	Mate/Matte	Plana/Flat	M20
00100700026B	20,00	1,50 - 2,03	25,00	1,58	Brillante/Glossy	Plana/Flat	
00100700026M	20,00	1,50 - 2,03	25,00	1,58	Mate/Matte	Plana/Flat	
00100700028B	20,63	0,79 - 2,77	26,19	1,58	Brillante/Glossy	Plana/Flat	
00100700028M	20,63	0,79 - 2,77	26,19	1,58	Mate/Matte	Plana/Flat	
00100700097	22,00	0,80 - 4,00	27,80	2,00	Mate/Matte	Plana/Flat	M22
00100700030B	22,23	0,79 - 2,77	27,38	1,58	Brillante/Glossy	Plana/Flat	
00100700030M	22,23	0,79 - 2,77	27,38	1,58	Mate/Matte	Plana/Flat	
00100700098	24,00	0,80 - 4,00	28,00	2,00	Mate/Matte	Plana/Flat	M24
00100700032B	25,40	0,79 - 2,77	30,96	1,58	Brillante/Glossy	Plana/Flat	
00100700032M	25,40	0,79 - 2,77	30,96	1,58	Mate/Matte	Plana/Flat	
00100700099	26,00	0,80 - 4,00	30,00	2,00	Mate/Matte	Plana/Flat	M26

Tapones y
Capuchones
Plugs & Caps

Color: Natural / Negro - Natural / Black



MTVV Tapón ventilación
Vent plug

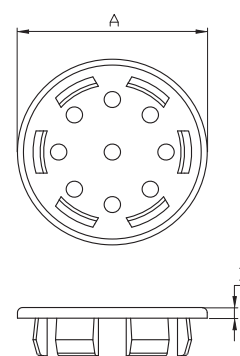

Material: PA66

UL94 V2/V0

RoHS

Referencia Reference	A. Panel H. Diameter	G. Panel P. Thickness	A	B	Acabado Finishing	Tipo cabeza Head type
00100700035	22,23	0,79 - 2,77	27,38	1,58	Mate/Matte	Plana/Flat
00100700036	25,40	0,79 - 2,77	30,96	1,58	Mate/Matte	Plana/Flat

Color: Natural / Negro - Natural / Black

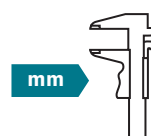

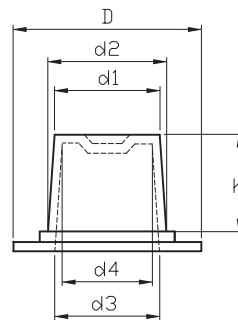
LHUT
Tapón / capuchón cónico
Tapered plug / cap

Material: LLDPE



Referencia Reference	d1	d2	D	h	d3	d4
01500703129	4,40	6,15	10,00	10,00	4,55	2,80
01500703130	6,00	7,75	11,00	10,00	6,15	4,40
01500703131	7,60	9,35	13,00	10,00	7,75	6,00
01500703132	8,40	10,15	14,00	10,00	8,55	6,80
01500703133	9,20	10,95	14,00	10,00	9,25	7,50
01500703134	9,90	11,65	15,00	10,00	10,05	8,30
01500703135	10,60	12,35	16,00	10,00	10,75	9,00
01500703136	11,30	13,05	17,00	10,00	11,55	9,80
01500703137	12,00	14,10	18,00	12,00	12,50	10,40
01500703138	12,50	14,60	18,00	12,00	13,30	11,20
01500703139	13,50	15,60	19,00	12,00	14,00	11,90
01500703140	14,00	16,10	19,00	12,00	1,45	12,40
01500703141	14,70	17,00	21,00	13,00	15,50	13,20
01500703142	16,30	18,60	22,00	13,00	17,00	14,70
01500703143	17,10	19,40	22,00	13,00	17,80	15,50
01500703144	17,50	20,10	24,00	15,00	18,50	15,90
01500703145	18,40	21,00	25,00	15,00	19,40	16,80
01500703146	19,00	21,60	25,00	15,00	20,00	17,50
01500703147	20,40	23,20	27,00	16,00	21,60	18,80
01500703148	20,70	23,50	28,00	16,00	21,90	19,10
01500703149	22,00	24,80	29,00	16,00	23,20	20,40
01500703150	23,20	26,35	30,00	18,00	24,35	21,20
01500703151	24,50	27,80	32,00	19,00	26,20	22,90
01500703152	25,20	29,20	33,00	19,00	27,70	23,70
01500703153	27,80	31,10	35,00	19,00	29,50	26,20
01500703154	29,80	31,60	37,00	16,00	31,10	28,30
01500703155	31,40	35,10	38,00	21,00	33,40	29,70
01500703156	33,30	37,10	41,00	22,00	35,50	31,70
01500703157	36,70	40,50	45,00	22,00	39,00	35,20
01500703158	38,20	40,70	45,00	13,00	39,20	26,90
01500703159	38,40	43,30	48,00	23,00	41,40	36,60
01500703160	39,60	42,90	48,00	19,00	41,90	38,00
01500703161	41,40	44,70	49,00	19,00	43,00	39,70
01500703162	44,40	47,70	51,00	19,00	46,10	42,80
01500703163	45,20	49,60	54,00	25,00	48,00	43,60
01500703164	46,40	51,00	55,00	25,00	49,60	45,20
01500703165	52,50	56,90	62,00	25,00	55,20	50,80
01500703166	54,00	59,25	65,00	25,00	57,25	52,50
01500703167	54,20	58,60	65,00	25,00	57,00	52,60
01500703168	58,40	62,80	67,00	25,00	61,10	56,70
01500703169	60,80	65,90	71,00	29,00	64,30	59,20
01500703170	67,10	70,40	75,00	19,00	68,70	65,40
01500703171	72,40	75,70	83,00	19,00	74,10	70,80
01500703172	84,50	87,80	92,00	19,00	85,70	82,40

Color: Amarillo - Yellow





Tapones y
Capuchones
Plugs & Caps

PARA ROSCAS/FOR THREADS

ROSCA INTERNA/INTERNAL THREAD				
Referencia	MÉTRICA/METRIC		GAS/BSP	PG
Reference	Rosca normal/ Core thread	DIN 13	DIN 259	DIN 40430
01500703129	M6x1,00	M6x0,50		
01500703130	M8x1,25	M8x1,00		
01500703131	M10x1,50			
01500703132		M10x1,00	R 1/8"	
01500703133	M12x1,75			
01500703134		M12x1,00 / M12x1,50		
01500703135	M14x2,00			PG7
01500703136		M14x1,50	R 1/4"	
01500703137				
01500703138	M16x2,00			PG9
01500703139		M16x1,50		
01500703140	M18x2,50		R 3/8"	
01500703141		M18x1,50		
01500703142	M20x2,50	M18x2,00 / M20x2,00		
01500703143		M20x1,50		PG11
01500703144			R 1/2"	
01500703145	M22x2,50	M22x2,00		PG13,5
01500703146	M24x3,00	M22x1,50		
01500703147		M24x2,00	R 5/8"	PG16
01500703148		M24x1,50		
01500703149	M27x3,00			
01500703150		M27x2,00 / M26x1,50	R 3/4"	
01500703151	M30x3,50	M27x1,50		
01500703152		M30x2,00 / M28x1,50	R 7/8"	PG21
01500703153	M33x3,50	M30x1,50		
01500703154	M36x4,00	M33x2,00 / M32x1,50 / M33x1,50	R 1"	
01500703155		M36x3,00 / M35x1,50		
01500703156	M39x4/M42x4	M39x3/M36x2/M36x1,5/M38x1,5	R 1 1/8"	PG29
01500703157		M42x3/M39x2/M42x2/ M39x1,5/M40x1,5	R 1 1/4"	
01500703158				
01500703159	M45x4,50			
01500703160	M48x5,00	M45x3,00 / M42x1,50	R 1 3/8"	
01500703161		M45x2,00 / M45x1,50		
01500703162		M48x2,00	R 1 1/2"	PG36
01500703163		M48x1,50		
01500703164		M52x3,00 / M52x2,00 / M50x1,50		
01500703165		M56x2,00 / M55x1,50		PG42
01500703166		M60x4,00		
01500703167		M58x2,00 / M60x2,00 / M58x1,50	R 2"	PG48
01500703168		M64x4,00 / M60x1,50 / M62x1,50		
01500703169		M68x4,00 / M64x2,00/M65x1,50	R 2 1/4"	
01500703170		M72x2,00 /M70x1,50		
01500703171		M76x2,00 / M75x1,50	R 2 1/2"	
01500703172		M90x4,00	R 3"	

ROSCA EXTERNA/EXTERNAL THREAD				
Referencia	MÉTRICA/METRIC		GAS/BSP	PG
Reference	Rosca normal/ Core thread	DIN 13	DIN 259	DIN 40430
01500703129	M4x0,70	M4x0,50		
01500703130	M5x0,80 / M6x1,00	M5x0,50 / M6x0,50		
01500703131				
01500703132	M8x1,25	M8x1,00		
01500703133				
01500703134		M10x1,00		
01500703135	M10x1,50		R 1/8"	
01500703136				
01500703137	M12x1,75	M12x1,00 / M12x1,50		
01500703138				PG7
01500703139			R 1/4"	
01500703140	M14x2,00	M14x1,50		
01500703141				
01500703142	M16x2,00	M16x1,50		PG9
01500703143			R 3/8"	
01500703144	M18x2,50	M18x2,00 / M18x1,50		
01500703145				
01500703146				PG11
01500703147	M20x2,50	M20x2,00 / M20x1,50		PG13,5
01500703148			R 1/2"	
01500703149	M22x2,50	M22x2,00 / M22x1,50		
01500703150	M24x3,00	M24x2,00 / M24x1,50	R 5/8"	PG16
01500703151				
01500703152	M27x3,00	M27x2,00 / M26x1,50 / M27x1,50	R 3/4"	
01500703153		M28x1,50		PG21
01500703154	M30x3,50	M30x2,00 / M30x1,50	R 7/8"	
01500703155	M33x3,50	M33x2,00 / M32x1,50 / M33x1,50		
01500703156		M35x1,50	R 1"	
01500703157		M38x1,50	R 1 1/8"	PG29
01500703158				
01500703159	M39x4,0	M39x3,00 / M39x2,00 / M39x1,50 / M40x1,50		
01500703160				
01500703161	M42x4,50	M42x3,00 / M42x2,00 / M42x1,50	R 1 1/4"	
01500703162	M45x4,50	M45x3,00 / M45x2,00 / M45x1,50	R 1 3/8"	
01500703163				
01500703164	M48x5,00	M48x3,00 / M48x2,00 / M48x1,50	R 1 1/2"	PG36
01500703165		M52x3,00 / M52x2,00 / M52x1,50	R 1 3/4"	PG42
01500703166		M56x3,00 / M56x2,00 / M56x1,50		
01500703167				
01500703168		M60x4 / M58x2 / M60x2 / M58x1,5 / M60x1,5	R 2"	PG48
01500703169		M62x1,50		
01500703170				
01500703171		M72x4,00 / M72x2,00 / M72x1,50		
01500703172				

LHUTA

Tapón/capuchón cónico Tapered plug and cap

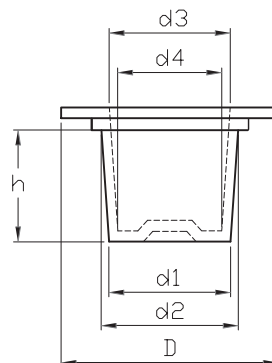

Material: LLDPE



RoHS

 Tapones y
Capuchones
Plugs & Caps

Referencia Reference	d1	d2	D	h	d3	d4
01500703098	4,40	6,30	22,00	11,00	4,60	2,70
01500703099	6,00	7,90	23,00	12,00	6,10	4,25
01500703100	7,60	9,50	25,00	11,00	7,80	5,90
01500703101	8,40	10,25	26,00	11,00	8,55	6,80
01500703102	9,20	11,00	26,00	11,00	9,25	7,50
01500703103	9,90	11,75	27,00	11,00	10,00	8,30
01500703104	10,60	12,40	28,00	11,00	10,60	8,80
01500703105	11,30	13,22	22,00	11,00	11,80	9,83
01500703106	12,00	14,20	30,00	13,00	12,45	10,40
01500703107	12,50	14,60	30,00	13,00	13,30	11,20
01500703108	13,80	15,90	31,00	13,00	14,10	12,00
01500703109	14,00	16,35	31,00	13,00	14,50	12,20
01500703110	15,00	17,20	33,00	15,00	15,50	13,40
01500703111	16,50	18,80	34,00	14,00	17,10	14,80
01500703112	17,40	19,55	34,00	14,00	17,80	15,60
01500703113	17,70	20,30	36,00	16,00	18,60	16,00
01500703114	18,60	21,15	37,00	16,00	19,45	16,90
01500703115	19,00	21,00	37,00	16,00	20,00	17,30
01500703116	20,80	23,50	39,00	17,00	21,80	18,00
01500702000	21,20	24,00	40,00	17,00	22,10	19,30
01500703117	22,30	25,20	41,00	17,00	23,40	20,40
01500703118	23,70	27,00	42,00	19,00	25,10	21,80
01500703119	25,00	28,30	44,00	20,00	26,40	23,00
01500703120	28,30	31,30	47,00	20,00	29,70	26,40
01500703121	29,80	32,85	49,00	20,00	31,20	28,10
01500703122	32,00	35,50	50,00	22,00	33,60	29,80
01500703123	33,80	37,82	52,00	23,00	36,00	31,94
01500703124	36,39	40,23	54,00	22,00	38,40	34,52
01500703125	39,24	43,10	60,00	23,00	41,30	37,24
01500703126	41,30	44,80	70,00	20,00	43,00	29,50
01500703127	44,40	47,90	64,00	20,00	46,10	42,60
01500703128	60,80	66,05	85,00	30,00	64,42	59,17

Color: Amarillo - Yellow

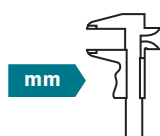

LHUS

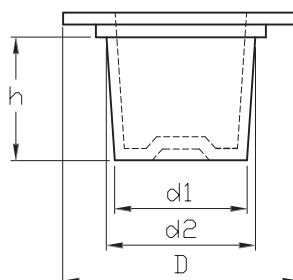
Tapón cónico
Tapered plug

Material: LDPE

RoHS

PARA ROSCA INTERNA
FOR INTERNAL THREAD

MÉTRICA/METRIC

Referencia Reference	d1	d2	D	h	Rosca normal Core thread	DIN 13
00300700296	4,40	6,10	10,00	10,00	M7x1,00	M6x0,50
00300700297	6,00	7,70	11,00	10,00	M9x1,25	
00300700298	7,60	9,30	13,00	10,10		M10x0,75
00300700299	8,40	10,10	14,00	10,00		M11
00300700300	9,20	10,90	14,00	10,00		M12x1,25
00300700301	9,90	11,60	15,00	10,00		
00300700302	10,60	12,30	16,00	10,00	M14x2,00	
00300700303	11,20	13,00	17,00	10,00		M14x1,00
00300700304	12,00	14,10	18,00	12,00		M15x1,00
00300700305	12,50	14,60	18,00	12,00		M16x1,50
00300700306	13,40	15,50	19,00	12,00		
00300700307	14,00	16,10	19,00	12,00		M17x2,00 / M18x2,00
00300700329	14,00	16,10	24,00	12,00		M17x1,00 / M18x2,00
00300700308	14,70	17,00	21,00	13,00		M18x1,00
00300700309	16,30	18,60	22,00	13,00	M20x2,50	M20x1,50
00300700311	17,50	20,00	24,00	15,00		M22x2,00
00300700312	18,50	21,00	25,00	15,00	M24x3,00	M22x1,00
00300700313	19,00	21,50	25,00	15,00		
00300700314	20,50	23,30	27,00	16,00		M24x0,75 / M25x2,00
00300700315	20,70	23,50	28,00	16,00		M25x1,50
00300700316	22,00	24,80	29,00	16,00		
00300700317	23,10	26,40	30,00	18,00	M30x3,50	M28x1,50
00300700318	24,40	27,70	32,00	19,00		
00300700319	26,40	29,20	33,00	19,00	M33x3,50	M30x1,00
00300700320	27,00	31,20	35,00	19,00		M33x2,00
00300700321	29,80	32,60	37,00	16,00		M34x1,50
00300700322	31,30	35,00	38,00	21,00		
00300700323	33,30	37,10	41,00	22,00		M39x2,00 / M40x3,00
00300700324	36,70	40,50	45,00	22,00	M45x4,50	M42x1,50
00300700325	39,00	42,50	48,00	23,00		
00300700326	39,60	42,90	48,00	19,00	M48x5,00	M45x2,00
00300700327	41,40	44,70	49,00	19,00		
00300700328	44,30	46,90	51,00	19,00		M50x3,00
00300700330	44,30	46,90	60,00	19,00		M50x3,00

Color: Natural - Natural

Tapones y
Capuchones
Plugs & Caps

mm



DTCC

Tapón cónico Tapered plug

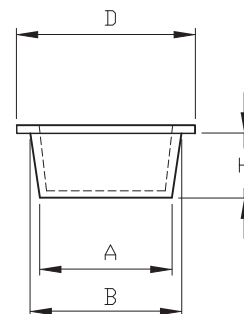

Material: LLDPE



RoHS

Tapones y
Capuchones
Plugs & Caps

Referencia Reference	A	B	D	H
01500703000	8,10	9,20	11,00	7,00
01500703001	9,80	11,00	12,00	7,00
01500703002	10,60	11,60	14,00	7,00
01500703003	11,40	12,40	15,00	7,00
01500703004	13,30	14,40	16,00	7,00
01500703005	14,00	15,10	17,00	7,00
01500703006	14,60	15,60	18,00	7,00
01500703007	15,30	16,40	18,00	7,00
01500703008	16,00	17,30	20,00	9,00
01500703009	17,40	18,80	21,00	9,00
01500703010	18,20	19,60	22,00	9,00
01500703011	18,70	20,00	24,00	9,00
01500703012	19,80	21,20	24,00	9,00
01500703013	20,30	22,60	25,00	14,00
01500703014	21,20	23,30	26,00	14,00
01500703015	23,00	25,00	28,00	14,00
01500703016	24,30	26,40	30,00	14,00
01500703017	25,70	27,80	30,00	14,00
01500703018	27,20	29,30	32,00	14,00
01500703019	30,00	32,00	35,00	14,00
01500703020	32,00	34,00	38,00	14,00
01500703021	33,60	36,00	40,00	14,00
01500703022	34,50	37,00	41,00	14,00
01500703023	36,00	38,40	42,00	14,00
01500703024	37,90	40,00	44,00	14,00
01500703025	38,50	41,00	43,00	14,00
01500703026	39,80	42,00	46,00	14,00
01500703027	41,30	43,50	47,00	14,00
01500703028	43,90	46,50	52,00	13,50
01500703029	45,50	47,50	52,00	13,50
01500703030	47,90	50,00	54,00	13,50
01500703031	49,80	51,80	58,00	14,00
01500703032	50,50	53,30	58,00	14,00
01500703033	52,50	53,30	58,00	13,50
01500703034	54,50	56,20	63,00	14,00
01500703035	55,50	58,00	61,00	13,50
01500703036	57,00	59,00	63,00	13,50
01500703037	58,50	60,80	64,00	13,50

Referencia Reference	A	B	D	H
01500703038	60,50	63,00	66,00	13,50
01500703041	60,80	66,30	75,00	29,00
01500703039	61,30	63,50	67,00	14,00
01500703040	62,50	64,80	68,00	13,50
01500703042	66,00	67,50	72,00	13,00
01500703043	67,90	69,50	74,00	13,00
01500703044	69,80	71,70	79,00	18,00
01500703045	71,50	73,40	77,00	13,00
01500703046	72,80	74,00	79,00	18,00
01500703047	74,00	76,60	85,00	17,00
01500703050	76,00	82,00	90,00	29,00
01500703048	76,50	79,00	87,00	17,00
01500703049	77,50	80,00	88,00	17,00
01500703051	81,50	83,60	92,00	17,00
01500703052	84,00	87,10	95,00	17,00
01500703053	86,50	89,00	97,00	17,00
01500703054	88,00	91,50	100,00	17,00
01500703055	91,50	94,00	102,00	17,00
01500703056	94,00	96,00	105,00	17,00
01500703057	94,00	99,00	107,00	17,00
01500703058	98,50	102,50	110,00	30,00
01500703059	101,50	104,00	112,00	17,00
01500703060	104,00	106,50	115,00	17,00
01500703061	106,00	111,00	120,00	23,00
01500703062	109,00	112,50	123,00	30,00
01500703063	114,00	117,00	125,00	17,00
01500703064	118,00	123,00	130,00	23,00
01500703065	123,00	127,00	135,00	30,00
01500703066	127,00	133,00	140,00	23,00
01500703067	133,00	137,00	143,00	23,00
01500703068	138,00	143,00	152,00	27,00
01500703069	142,50	148,00	159,50	33,00
01500703070	146,80	153,00	159,50	33,00
01500703071	153,00	157,50	167,00	38,00
01500703072	156,00	161,50	170,00	38,00
01500703073	159,00	163,00	172,00	38,00
01500703074	164,00	166,00	174,00	23,00
01500703075	168,00	175,00	190,00	38,00

Color: Natural / Amarillo - Natural / Yellow

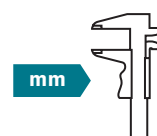

Referencia Reference	A	B	D	H
01500703076	169,00	172,00	179,00	23,00
01500703077	173,00	185,00	195,00	38,00
01500703078	177,00	185,00	195,00	38,00
01500703079	187,50	191,50	197,50	23,00
01500703080	192,00	200,00	215,00	38,00
01500703081	199,00	204,00	214,00	38,00
01500703082	203,50	208,50	216,00	23,00
01500703083	207,50	212,00	222,00	23,00
01500703084	216,00	222,00	235,00	46,00
01500703085	221,50	227,00	235,00	23,00
01500703086	223,00	230,00	239,00	38,00

Referencia Reference	A	B	D	H
01500703087	232,00	239,00	250,00	46,00
01500703088	239,00	250,00	263,00	46,00
01500703089	249,00	254,00	264,00	46,00
01500703090	250,00	261,00	280,00	46,00
01500703091	270,00	281,00	296,00	46,00
01500703092	278,00	286,00	296,00	46,00
01500703093	284,00	293,00	315,00	46,00
01500703094	292,00	299,00	315,00	46,00
01500703095	298,00	301,00	314,00	23,00
01500703096	305,00	315,00	330,00	48,00
01500703097	313,00	320,00	335,00	50,00

Color: Natural / Amarillo - Natural / Yellow

Tapones y
Capuchones
Plugs & Caps

DFZ Tapón estriado
Ratchet plug

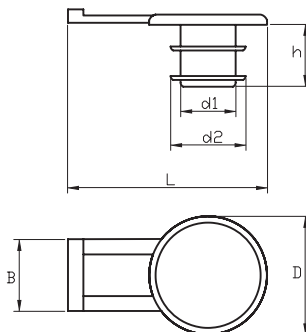

Material: LLDPE



PARA ROSCA INTERNA
FOR INTERNAL THREAD

MÉTRICA/METRIC

Referencia Reference	d1	d2	D	h	L	B	DIN 13
01500500086	6,40	9,50	16,00	8,00	31,50	12,00	M10x1,00
01500500087	7,90	11,10	19,00	8,00	34,50	12,00	M12x1,50
01500500088	9,90	13,10	20,00	10,00	35,50	12,00	M14x1,50
01500500089	11,90	15,10	24,00	11,00	40,50	14,00	M16x1,50
01500500090	17,40	21,50	29,00	11,50	45,50	14,00	M22x1,50

Color: Rojo - Red



DFV Tapón estriado Ribbed plug

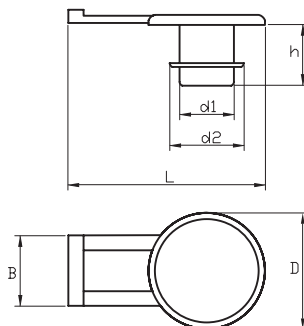

Material: LLDPE

RoHS

PARA ROSCA INTERNA
FOR INTERNAL THREAD

MÉTRICA/METRIC

Referencia Reference	d1	d2	D	h	L	B	DIN 13
01500500091	9,80	11,80	16,00	7,00	26,00	12,00	M12x1,50
01500500092	11,20	13,80	19,00	7,00	29,00	12,00	M14x1,50
01500500093	14,00	15,80	21,50	7,00	33,70	14,00	M16x1,50
01500500094	15,50	17,80	25,00	7,50	37,50	14,00	M18x1,50
01500500095	17,50	19,80	27,00	7,50	39,50	14,00	M20x1,50
01500500096	19,50	21,80	29,00	7,50	45,50	14,00	M22x1,50
01500500097	21,50	23,80	30,00	7,50	46,00	14,00	M24x1,50
01500500098	22,80	25,80	32,00	8,00	47,00	14,00	M26x1,50
01500500099	26,50	29,50	35,00	10,00	49,00	14,00	M30x2,00
01500500100	32,50	35,50	40,00	10,00	54,00	14,00	M36x2,00
01500500101	38,50	41,50	50,00	10,00	65,00	15,00	M42x2,00
01500500102	41,50	44,50	50,00	10,00	65,00	15,00	M45x2,00
01500500103	48,50	51,50	59,00	10,00	74,00	15,00	M52x2,00

Color: Azul - Blue

LLST Tapón estriado Ribbed plug

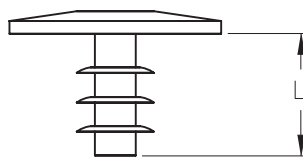

Material: LDPE

RoHS

PARA ROSCA INTERNA
FOR INTERNAL THREAD

MÉTRICA/METRIC

Referencia Reference	L	Número de estrias Number of ribs	DIN 13
00300700408	10,00	3,00	M8
00300700409	30,00	9,00	M8
00300700410	30,00	6,00	M10
00300700411	30,00	6,00	M12

Color: Natural - Natural



PLL Tapón cónico con lengüeta

Tapered plug with tab

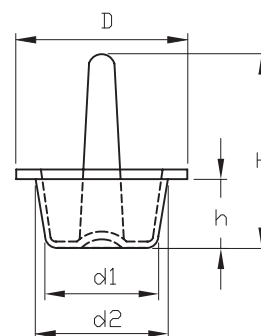

Material: TPE



Referencia Reference	d1	d2	D	h	H
01500600278	6,50	7,50	15,50	9,00	24,00
01500600279	8,50	9,50	17,50	9,00	24,00
01500600280	10,50	11,50	19,50	9,00	25,00
01500600281	12,50	13,50	21,50	9,00	25,00
01500600282	14,30	15,50	23,50	9,00	25,00
01500600283	16,20	17,60	25,50	9,00	25,00
01500600284	18,00	19,40	27,50	9,00	25,00
01500600285	20,00	21,40	29,50	9,00	25,00
01500600286	22,00	23,50	28,50	9,00	25,00

Color: Negro - Black

Tapones y
Capuchones
Plugs & Caps



PARA ROSCAS/FOR THREADS

Referencia Reference	MÉTRICA/METRIC DIN ISO 13	GAS/BSP DIN ISO 228	UN	UNC	UNF	UNEF
				ANSI/ASME B 1.1a - 1984		
01500600278	M8x1,00		5/16	7/16	5/16	5/16
01500600279	M10x1,00	G 1/8"	3/8	7/16		3/8
01500600280	M12x1,50	G 1/4"	1/2		9/16	
01500600281	M14x1,50		9/16	9/16	5/8	9/16
01500600282	M16x1,50	G 3/8"	5/8			5/8
01500600283	M18x1,50		11/16	3/4		11/16
01500600284	M20x1,50	G 1/2"				
01500600285	M22x1,50					
01500600286	M24x1,50		15/16			15/16



DTPA

Tapón paralelo Parallel plug

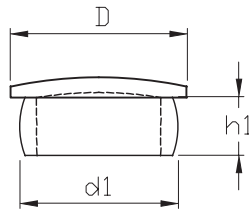

Material: LDPE

RoHS

PARA ROSCAS/ FOR THREADS

MÉTRICA/METRIC

GAS/BSP

Referencia Reference	d1	D	h1	Rosca normal/ Core thread	DIN 13	DIN 259
00300700344	2,00	3,50	7,00	M2,5x0,45	M2,2x0,25	
00300700345	3,00	12,80	5,00	M3,5x0,50	M3,5x0,35	
00300700346	4,40	9,00	5,50	M5x0,80		
00300700347	4,60	7,00	5,00		M5x0,50	
00300700348	5,20	11,00	6,00	M6x1,00	M6x0,75	
00300700349	5,40	12,00	7,50	M6x1,00	M6x0,75	
00300700350	6,00	11,00	7,00	M7x1,00		
00300700351	6,60	7,50	5,00			
00300700352	7,00	11,00	6,50	M8x1,25	M8x1,00	
00300700353	7,30	11,00	6,00	M8x1,25	M8x0,75 / M8x1,00	
00300700354	7,50	11,00	4,50		M8x0,75	
00300700355	8,00	12,00	7,50	M9x1,25	M9x1,00	
00300700356	8,50	12,00	8,00	M10x1,50		
00300700357	8,80	11,50	8,00	M10x1,50	M10x1,25	R 1/8
00300700358	9,30	12,00	9,00		M10x0,75 / M10x1,00	R 1/8
00300700359	10,00	15,00	9,00	M11x1,50	M11x1,00	
00300700360	10,00	12,00	9,00	M11x1,50	M11x1,00	
00300700361	10,70	15,00	9,00	M12x1,75	M12x1,25 / M12x1,50	
00300700362	11,90	14,90	8,00	M12x1,75		R 1/4
00300700363	12,00	23,00	8,00	M14x2,00		R 1/4
00300700364	12,60	17,50	9,00	M14x2,00	M14x1,50	
00300700365	13,20	17,50	8,00	M14x2,00	M14x1 / M14x1,25	
00300700366	13,80	19,50	8,50		M14x0,5 / M14x1,5	
00300700367	14,80	18,50	9,00	M16x2,00	M16x1,50	
00300700368	15,40	19,50	8,50	M18x2,50	M16x0,75 / M16x1,00	R 3/8
00300700369	16,00	19,00	8,50	M18x2,50	M16x0,75	R 3/8
00300700370	16,80	20,00	9,00		M18x1,50	
00300700371	17,20	23,00	9,50		M18x0,75 / M16x1,00	
00300700372	18,90	21,50	9,20		M20x2,00	
00300700373	19,60	25,50	9,00		M20x0,75	R 1/2
00300700374	19,60	29,00	9,30		M20x0,75	R 1/2
00300700375	20,50	25,50	9,00		M22x2,00	
00300700376	21,10	26,00	13,00	M24x3,00	M22x1,00 / M22x1,50	R 5/8
00300700377	22,70	29,00	9,00		M24x2,00	
00300700378	23,00	27,40	19,60		M24x1,00	
00300700379	24,00	27,00	12,50	M27x3,00	M25x1,00	R 3/4
00300700380	25,00	32,00	13,00	M27x3,00	M26x1,00 / M26x1,50	R 3/4
00300700381	25,00	36,00	13,00	M27x3,00	M26x1,00 / M26x1,50	R 3/4

Color: Natural - Natural

Tapones y
Capuchones
Plugs & Caps

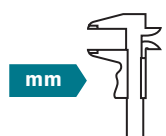

DTPA Tapón paralelo
Parallel plug

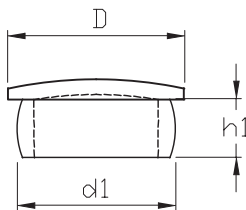

Material: LDPE



PARA ROSCAS / FOR THREADS
MÉTRICA / METRIC GAS / BSP

Tapones y
Capuchones
Plugs & Caps

Referencia Reference	d1	D	h1	Rosca normal/ Core thread	DIN 13	DIN 259
00300700382	26,00	31,50	12,00			
00300700383	27,10	29,60	15,00	M30x3,50	M28x1,00 / M30x3,00	
00300700384	29,00	34,50	1,00		M30x1,50 / M30x2,00	R 7/8
00300700385	31,20	38,00	13,00	M33x3,50	M32x1,50 / M33x2,00	R 1
00300700386	31,20	45,00	13,00	M33x3,50	M32x1,50 / M33x2,00	R 1
00300700387	33,50	41,00	12,10		M35x1,50	
00300700388	34,00	40,00	20,00		M36x20	
00300700389	35,50	47,00	14,50	M39x4,00		R 1 1/8
00300700390	36,50	47,00	18,00		M38x1,50 / M39x3,00	R 1 1/8
00300700391	39,70	46,00	16,00		M42x3,00	R 1 1/4
00300700392	39,70	51,00	15,00		M42x3,00	R 1 1/4
00300700393	39,70	42,00	15,00		M42x3,00	R 1 1/4
00300700394	42,00	44,50	12,80		M45x3,00	
00300700395	43,30	50,50	14,50	M48x5,00	M45x2,00	
00300700396	45,50	51,00	16,00		M48x3,00	
00300700397	46,00	51,50	16,50			R 1 1/2
00300700398	46,20	58,00	16,50			R 1 1/2
00300700399	51,30	57,00	15,50	M56x5,50	M52x1,50 / M52x2,00	R 1 3/4
00300700400	52,30	60,00	16,00	M56x5,50	M58x3,00	R 1 3/4
00300700401	55,30	59,50	19,50	M60x5,50	M58x3,00	
00300700402	55,50	58,60	15,60	M60x5,50	M60x2 / M60x3 / M62x4	R2
00300700403	57,20	62,30	19,80		M64x3,00 / M65x4,00	
00300700404	61,50	47,70	20,00	M68x6,00	M72x2 / M72x3 / M76x6	
00300700405	70,00	80,00	18,00			
00300700406	85,00	95,00	18,00			
00300700407	110,00	130,00	17,50			R 4

Color: Natural - Natural

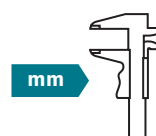

DTPO Tapón paralelo Parallel plug

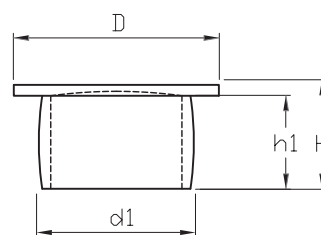
Material: LLDPE
RoHS

Tapones y
Capuchones
Plugs & Caps

Referencia Reference	d1	D	h1	H
01500600185S	7,20	7,20	4,10	6,80
01500600185K	7,20	14,00	4,10	6,80
01500600186S	8,40	8,40	4,60	7,30
01500600186K	8,40	14,00	4,60	7,30
01500600187S	9,00	9,00	4,50	6,50
01500600187K	9,00	14,00	4,50	6,50
01500600188S	10,40	10,40	4,60	7,00
01500600188K	10,40	14,00	4,60	7,00
01500600224S	10,70	10,70	4,70	7,00
01500600224K	10,70	14,00	4,70	7,00
01500600190S	11,70	11,70	5,80	8,50
01500600190K	11,70	16,00	5,80	8,50
01500600191S	12,30	12,30	5,50	8,50
01500600191K	12,30	16,00	5,50	8,50
01500600192S	13,70	13,70	7,00	10,00
01500600192K	13,70	20,00	7,00	10,00
01500600193S	14,30	14,30	5,50	7,50
01500600193K	14,30	20,00	5,50	7,50
01500600194S	15,60	15,60	8,00	10,00
01500600194K	15,60	20,00	8,00	10,00
01500600195S	16,50	16,50	5,50	7,50
01500600195K	16,50	22,00	5,50	7,50
01500600196S	17,10	17,10	8,00	10,00
01500600196K	17,10	22,00	8,00	10,00
01500600197S	18,40	18,40	8,00	10,50
01500600197K	18,40	25,00	8,00	10,50
01500600198S	19,60	19,60	8,00	10,50
01500600198K	19,60	25,00	8,00	10,50
01500600225GK	19,60	30,00	8,00	10,50
01500600201S	20,70	20,70	8,00	10,50
01500600201K	20,70	25,00	8,00	10,50
01500600199S	21,20	21,20	7,50	10,00
01500600199K	21,20	25,00	7,50	10,00
01500600200S	21,70	21,70	8,00	10,00
01500600200K	21,70	25,00	8,00	10,00
01500600202S	22,40	22,40	9,00	12,00
01500600202K	22,40	28,00	9,00	12,00
01500600203S	23,60	23,60	9,00	11,50

Color: Natural - Natural

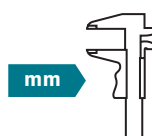



**Tapones y
Capuchones**
Plugs & Caps

PARA ROSCAS/FOR THREADS				
Referencia		MÉTRICA/METRIC	GAS/BSP	PG
Reference	Rosca normal/ Core thread	DIN ISO 13	DIN 259	DIN 40430
01500600185S	M8x1,00			
01500600185K	M8x1,00			
01500600186S				
01500600186K				
01500600187S		M10x1,00	R 1/4"	
01500600187K		M10x1,00	R 1/4"	
01500600188S	M12x1,50			PG7
01500600188K	M12x1,50			PG7
01500600224S				
01500600224K				
01500600190S		M12x1,00		
01500600190K		M12x1,00		
01500600191S		M14x1,50	R 1/4"	
01500600191K		M14x1,50	R 1/4"	
01500600192S				
01500600192K				
01500600193S	M16x1,50			PG9
01500600193K	M16x1,50			PG9
01500600194S			R 3/8"	
01500600194K			R 3/8"	
01500600195S	M18x2,00	M18x1,50		
01500600195K	M18x2,00	M18x1,50		
01500600196S				
01500600196K				
01500600197S		M20x1,50		
01500600197K		M20x1,50		
01500600198S			R 1/2"	PG13,5
01500600198K			R 1/2"	PG13,5
01500600225GK			R 1/2"	PG13,5
01500600201S		M22x1,5		
01500600201K		M22x1,5		
01500600199S		M22x1,5	R 5/8"	
01500600199K		M22x1,5	R 5/8"	
01500600200S	M24x2,00			PG16
01500600200K	M24x2,00			PG16
01500600202S		M24x1,50		
01500600202K		M24x1,50		
01500600203S				

DTPO Tapón paralelo

Parallel plug

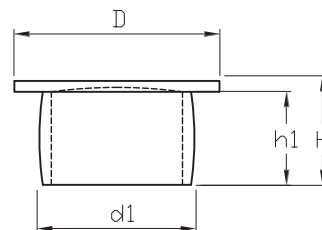

Material: LLDPE

RoHS

Tapones y
Capuchones
Plugs & Caps

Referencia Reference	d1	D	h1	H
01500600203K	23,60	28,00	9,00	11,50
01500600204S	24,60	24,60	9,00	12,00
01500600204K	24,60	28,00	9,00	12,00
01500600205S	25,50	25,50	7,50	9,50
01500600205K	25,50	28,00	7,50	9,50
01500600206S	26,50	26,50	9,00	12,00
01500600206K	26,50	28,00	9,00	12,00
01500600207S	29,00	29,00	12,00	15,00
01500600207K	29,00	36,00	12,00	15,00
01500600226K	31,00	36,00	11,00	14,00
01500600209S	31,80	31,80	10,00	12,50
01500600209K	31,80	36,00	10,00	12,50
01500600210S	33,50	33,50	12,00	15,00
01500600210K	33,50	36,00	12,00	15,00
01500600212S	36,50	36,50	15,00	18,00
01500600212K	36,50	42,00	15,00	18,00
01500600213S	38,40	38,40	10,00	12,50
01500600213K	38,40	42,00	10,00	12,50
01500600214S	39,00	39,00	15,00	18,00
01500600214K	39,00	42,00	15,00	18,00
01500600215S	40,00	40,00	15,00	18,00
01500600215K	40,00	42,00	15,00	18,00
01500600216S	46,00	46,00	18,00	21,00
01500600216K	46,00	55,00	18,00	21,00
01500600217S	48,50	48,50	12,00	15,00
01500600217K	48,50	55,00	12,00	15,00
01500600218S	51,50	51,50	18,00	21,00
01500600218K	51,50	55,00	18,00	21,00
01500600219S	55,00	55,00	18,00	21,00
01500600219K	55,00	63,00	18,00	21,00
01500600220S	58,00	58,00	18,00	21,00
01500600220K	58,00	63,00	18,00	21,00
01500600350S	66,00	66,00	18,00	21,00
01500600350K	66,00	70,00	18,00	21,00
01500600351K	71,00	78,00	18,00	21,50
01500600352S	78,00	78,00	18,00	21,00
01500600352K	78,00	83,00	18,00	21,00
01500600353K	86,00	90,00	18,00	20,00

Color: Natural - Natural

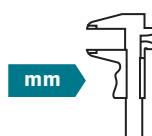



PARA ROSCAS/FOR THREADS

Referencia		MÉTRICA/METRIC	GAS/BSP	PG	
Reference	Rosca normal/ Core thread	DIN ISO 13	DIN 259	DIN 40430	
01500600203K					
01500600204S		M26x1,50	R 3/4"		
01500600204K		M26x1,50	R 3/4"		
01500600205S	M27x2,00	M27x1,50			
01500600205K	M27x2,00	M27x1,50			
01500600206S		M28x1,50			
01500600206K		M28x1,50			
01500600207S		M30x2,00	M30x1,50	R 7/8" PG21	
01500600207K		M30x2,00	M30x1,50	R 7/8" PG21	
01500600226K		M30x1,50	R 7/8"		
01500600209S		M33x2,00	M33x1,50	R 1"	
01500600209K		M33x2,00	M33x1,50	R 1"	
01500600210S		M35x1,50			
01500600210K		M35x1,50			
01500600212S	M39x3,00	M38x1,50	R 1 1/8"	PG29	
01500600212K	M39x3,00	M38x1,50	R 1 1/8"	PG29	
01500600213S		M39x2,00	M39x1,50		
01500600213K		M39x2,00	M39x1,50		
01500600214S		M40x1,50			
01500600214K		M40x1,50			
01500600215S		M42x3,00	M40x1,50	R 1 1/4"	
01500600215K		M42x3,00	M40x1,50	R 1 1/4"	
01500600216S		M48x3,00	M48x2,00	M45x1,50	R 1 1/2" PG36
01500600216K		M48x3,00	M48x2,00	M45x1,50	R 1 1/2" PG36
01500600217S			M48x1,50		
01500600217K			M48x1,50		
01500600218S	M56x4,00	M52x2,00	M52x1,50	R 1 3/4"	
01500600218K	M56x4,00	M52x2,00	M52x1,50	R 1 3/4"	
01500600219S		M56x2,00	M55x1,50	PG42	
01500600219K		M56x2,00	M55x1,50	PG42	
01500600220S		M58x2,00	M58x1,50	R 2"	
01500600220K		M58x2,00	M58x1,50	R 2"	
01500600350S					
01500600350K					
01500600351K			M72x1,50		
01500600352S		M80x3,00			
01500600352K		M80x3,00			
01500600353K	M90x4,00		R 3"		

Tapones y
Capuchones
Plugs & Caps

DTPAA

Tapón paralelo Parallel plug

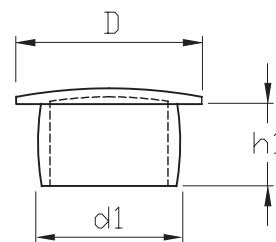

Material: LLDPE



RoHS

Tapones y
Capuchones
Plugs & Caps

Referencia Reference	d1	D	h1
01500600139	6,30	10,00	4,00
01500600140	7,20	11,20	6,00
01500600141	8,40	11,20	5,50
01500600142	8,80	11,20	7,00
01500600143	9,20	14,40	5,50
01500600144	10,10	14,40	5,50
01500600145	10,70	14,40	7,00
01500500127	11,30	14,40	9,50
01500600146	11,80	14,40	5,50
01500600147	12,30	18,50	7,00
01500600148	13,00	18,70	7,00
01500500128	13,30	18,70	7,00
01500600149	13,60	18,70	7,00
01500500129	14,00	18,70	7,00
01500600150	14,40	18,70	7,00
01500600151	15,00	18,70	7,00
01500600152	15,80	18,70	7,00
01500600153	16,50	18,70	7,00
01500600154	17,10	24,60	9,00
01400500130	17,80	24,60	9,00
01500600155	18,50	24,60	9,00
01500500131	18,90	24,50	7,00
01500500132	19,20	24,60	3,80
01500600156	19,60	25,00	8,00
01500600157	20,10	24,50	9,00
01500500133	20,70	24,50	9,00
01500600158	21,20	24,50	9,00
01500500134	21,70	24,50	9,00
01500600159	22,40	24,50	9,00
01500500135	23,00	28,50	9,00
01500600160	23,60	28,50	9,00
01500600161	24,00	28,50	9,00
01500600162	24,60	28,50	9,00
01500600163	25,30	28,50	9,00
01500600164	26,50	28,50	9,00
01500600165	27,00	34,80	12,00
01500600166	27,50	34,80	12,00
01500600167	28,80	34,80	12,00

Color: Natural - Natural

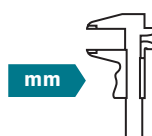



Tapones y
Capuchones
Plugs & Caps

PARA ROSCAS/FOR THREADS					
Referencia	MÉTRICA/METRIC			GAS/BSP	PG
Reference	Rosca normal/ Core thread	DIN ISO 13		DIN 259	DIN 40430
01500600139					
01500600140	M8x1,25	M8x1,00			
01500600141	M9x1,25				
01500600142	M10x1,50			R 1/8"	
01500600143	M10x1,50	M10x1,25	M10x1,00		
01500600144	M12x1,75	M12x1,50			
01500600145	M12x1,75	M12x1,50			
01500500127		M12x1,25	M12x1,00		PG7
01500600146				R 1/4"	PG7
01500600147	M14x2,00				
01500600148					
01500500128		M14x1,50	M14x1,25		PG9
01500600149			M14x1,00	R 3/8"	
01500500129	M16x2,00		M16x1,00	R 3/8"	
01500600150	M16x2,00				PG11
01500600151		M16x1,50			
01500600152	M18x2,50		M16x1,00		
01500600153		M18x2,00	M18x1,50	M18x1,00	R 1/2" PG13,5
01500600154		M18x2,00	M18x1,50	M18x1,00	PG13,5
01500500130	M20x2,50	M20x2,00			R 5/8" PG16
01500600155		M20x2,00	M20x1,50	M20x1,00	
01500500131	M20x2,50				
01500500132					
01500600156	M22x2,50				
01500600157	M22x2,50		M22x1,50		R 3/4"
01500500133	M22x2,50				
01500600158	M24x3,00				PG21
01500500134	M24x3,00				PG21
01500600159			M24x1,50		R 7/8"
01500500135			M24x1,50		R 1"
01500600160					R 1"
01500600161	M27x3,00				
01500600162	M27x3,00				
01500600163	M27x3,00	M27x2,00	M27x1,50		R 1 1/8" PG29
01500600164	M30x3,50				PG29
01500600165	M30x3,50				
01500600166		M30x3,00			R 1 3/8"
01500600167	M33x3,50		M30x2,00	M30x1,50	R 1 1/2" PG36

DTPAA

Tapón paralelo Parallel plug

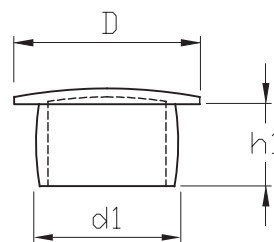

Material: LLDPE



RoHS

Tapones y
Capuchones
Plugs & Caps

Referencia Reference	d1	D	h1
01500600168	30,50	34,80	12,00
01500600169	31,60	34,80	12,00
01500600170	32,60	34,80	12,00
01500600171	34,60	40,40	12,00
01500600172	35,50	40,40	12,00
01500600173	36,70	40,40	12,00
01500500136	39,00	49,30	16,00
01500500137	39,10	43,00	16,00
01500600174	39,50	43,00	16,00
01500500138	40,70	49,30	16,00
01500600175	42,50	49,30	16,00
01500600176	46,20	58,70	18,00
01500600177	51,50	58,70	18,00
01500500139	54,10	58,70	18,00
01500600178	58,20	64,80	18,00
01500600179	59,60	73,50	18,00
01500600180	73,70	82,30	17,40
01500600181	80,80	92,50	17,40
01500600182	86,50	99,30	17,40
01500600183	98,80	112,00	17,40
01500600184	112,00	123,00	17,40

Color: Natural - Natural

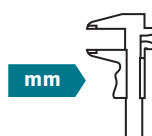



PARA ROSCAS/FOR THREADS

Referencia	MÉTRICA/METRIC		GAS/BSP	PG	
Reference	Rosca normal/ Core thread	DIN ISO 13		DIN 259	DIN 40430
01500600168	M33x3,50		R 1 3/4"		
01500600169	M36x4,00	M33x2,00	M33x1,50	R 2"	PG48
01500600170	M36x4,00	M36x3,00			
01500600171		M36x2,00	M36x1,50	R 2 1/2"	
01500600172	M39x4,00	M39x3,00		R 2 3/4"	
01500600173	M39x4,00			R 3"	
01500500136	M42x4,50	M42x3,00	M39x1,50	R 3 1/2"	
01500500137	M42x4,50			R 4"	
01500600174					
01500500138	M45x4,50		M42x2,00	M42x1,50	
01500600175	M45x4,50	M45x3,00			PG9
01500600176	M48x5,00				
01500600177		M56x4,00			
01500500139	M60x5,50	M56x4,00	M56x3,00	M56x2,00	
01500600178	M64x6,00	M60x4,00	M60x2,00	M60x1,50	
01500600179	M64x6,00			R 5/8"	PG16
01500600180			M75x1,50		
01500600181		M80x4,00			
01500600182	M80x6,00				
01500600183				R 1 1/4"	
01500600184				R 1 3/4"	

Tapones y
Capuchones
Plugs & Caps

DTTZ Tapón paralelo Parallel plug

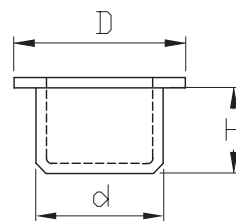

Material: LDPE / LLDPE RoHS

Tapones y
Capuchones
Plugs & Caps

Referencia Reference	Para agujero (d) For hole (d)	D	H
01500600001	3,00	6,50	4,50
01500600002	3,50	7,00	5,00
01500600003	4,00	7,50	5,00
00300700331	4,20	9,00	4,50
01500600004	4,50	8,00	5,00
01500600005	5,00	9,00	6,00
01500600006	5,50	9,00	6,00
01500600007	6,00	9,50	6,00
01500600008	6,50	10,00	7,00
01500600009	7,00	10,00	6,00
01500600010	7,50	10,50	6,50
01500600011	8,00	11,00	7,00
01500600012	8,50	11,50	7,50
01500600013	9,00	11,50	7,50
00300700332	9,10	12,90	6,50
01500600014	9,50	12,50	7,50
01500600015	10,00	13,00	8,50
01500600016	10,50	13,50	8,50
01500600017	11,00	14,50	8,50
01500600018	11,50	14,50	8,50
01500600019	12,00	14,50	9,00
00300700333	12,10	15,90	7,00
01500600020	12,50	15,50	9,00
01500600021	13,00	16,50	9,50
01500600022	13,50	16,50	9,50
01500600023	14,00	17,50	10,00
01500600024	14,50	17,50	9,50
01500600025	15,00	18,00	9,50
01500600026	15,50	18,50	9,50
01500600027	16,00	19,50	10,00
00300700334	16,00	19,60	7,70
01500600028	16,50	19,50	10,50
01500600029	17,00	20,50	10,50
01500600030	17,50	21,00	10,50
01500600031	18,00	21,50	10,50
01500600032	18,50	23,00	10,00
01500600033	19,00	22,00	10,00
01500600034	19,50	23,00	10,50

Color: Natural - Natural

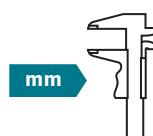



Tapones y
Capuchones
Plugs & Caps

PARA ROSCAS/FOR THREADS				
Referencia	MÉTRICA/METRIC			GAS/BSP
Reference	Rosca normal/ Core thread	DIN ISO 13		DIN 259 DIN 2402
01500600001				
01500600002	M4x0,70			
01500600003				
00300700331	M5x0,80			
01500600004	M5x0,80			
01500600005	M6x1,00			
01500600006				
01500600007	M7x1,00			
01500600008				
01500600009	M8x1,25			
01500600010		M8x1,00		
01500600011				
01500600012	M10x1,50			
01500600013			M10x1,00	R 1/8"
00300700332			M10x1,00 M10x0,25	
01500600014				
01500600015				
01500600016	M12x1,75	M12x1,50		DN10
01500600017				
01500600018			M12x1,00	R 1/4"
01500600019				
00300700333	M14x2,00			
01500600020	M14x2,00			
01500600021		M14x1,50		
01500600022				
01500600023				
01500600024	M16x2,00			
01500600025		M16x1,50		R 3/8"
01500600026				DN15
01500600027	M18x2,50			
00300700334	M18x2,50	M18x2,00	M17x1,00	
01500600028		M18x2,00		
01500600029			M18x1,50	
01500600030				
01500600031	M20x2,50			
01500600032		M20x2,00		
01500600033			M20x1,50	R 1/2"
01500600034	M22x2,00			

DTTZ Tapón paralelo

Parallel plug

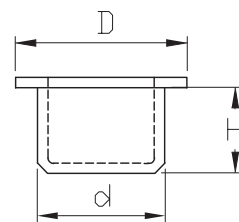

Material: LDPE / LLDPE RoHS

Tapones y
Capuchones
Plugs & Caps

Referencia Reference	Para agujero (d) For hole (d)	D	H
00300700335	19,60	23,30	8,30
01500600035	20,00	23,50	11,00
01500600036	20,50	24,50	10,50
01500600037	21,00	24,50	11,00
01500600038	21,50	25,50	11,00
01500600039	22,00	25,50	11,00
00300700336	22,30	25,00	11,70
01500600040	22,50	26,00	10,50
01500600041	23,00	27,00	10,50
01500600042	23,50	27,00	10,50
01500600043	24,00	28,00	11,50
01500600044	24,50	28,00	10,50
01500600045	25,00	28,00	12,00
00300700337	25,10	28,80	8,50
01500600046	25,50	29,00	10,50
01500600047	26,00	30,50	10,50
01500600048	26,50	30,00	10,50
01500600049	27,00	31,00	9,50
01500600050	27,50	31,00	10,50
01500600051	28,00	32,50	10,50
01500600052	28,50	32,00	10,00
01500600053	29,00	32,00	9,50
01500600054	29,50	33,00	10,50
01500600055	30,00	33,00	10,00
01500600056	30,50	34,00	10,00
01500600057	31,00	36,00	10,50
01500600058	31,50	35,00	10,50
00300700338	31,80	35,80	8,50
01500600059	32,00	37,00	10,50
01500600060	32,60	38,00	10,50
01500600061	33,00	38,00	10,50
01500600062	33,50	37,50	10,50
01500600063	34,00	38,50	10,50
01500600064	34,50	38,00	10,50
01500600065	35,00	40,00	10,50
01500600066	35,50	39,00	10,50
01500600067	36,00	41,00	11,00
01500600068	36,50	40,00	10,50

Color: Natural - Natural

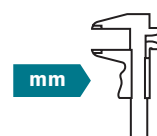



Tapones y
Capuchones
Plugs & Caps

PARA ROSCAS/FOR THREADS				
Referencia	MÉTRICA/METRIC		GAS/BSP	
Reference	Rosca normal/ Core thread	DIN ISO 13	DIN 259	DIN 2402
00300700335	M23x3,00		M20x0,75	
01500600035	M24x3,00			
01500600036	M25x3,00	M22x2,00		DN20
01500600037	M26x3,00	M22x1,50		
01500600038	M24x3,00		R 5/8"	
01500600039				
00300700336				
01500600040		M24x2,00		
01500600041		M24x1,50		
01500600042				
01500600043				
01500600044	M27x3,00		R 3/4"	
01500600045				
00300700337		M27x2,00		
01500600046		M27x2,00	M26x1,50	
01500600047			M26x1,50	
01500600048				
01500600049	M30x3,50	M28x1,50		
01500600050				
01500600051				
01500600052		M30x2,00	R 7/8"	
01500600053			M30x1,50	
01500600054				
01500600055				
01500600056			R 1"	
01500600057				
01500600058		M33x2,00	M32x1,50	
00300700338	M36x4,00	M33x2,00	M33x1,50	
01500600059				
01500600060	M32x3,50			
01500600061				
01500600062		M36x3,00		
01500600063				
01500600064				
01500600065				
01500600066	M39x4,00		M36x1,50	
01500600067				
01500600068				

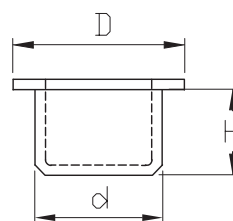
DTTZ
Tapón paralelo
Parallel plug

Material: LDPE / LLDPE
**Tapones y
Capuchones**
 Plugs & Caps

Referencia Reference	Para agujero (d) For hole (d)	D	H
01500600069	37,00	42,00	11,00
01500600070	37,50	41,50	10,50
01500600071	38,00	43,00	10,50
01500600072	38,50	42,00	10,50
01500600073	39,00	44,00	10,50
01500600074	39,50	45,00	12,50
01500600075	40,00	45,00	10,50
00300700339	40,50	47,00	9,00
01500600076	41,00	46,00	10,50
01500600077	42,00	46,50	10,50
01500600078	43,00	48,00	12,50
01500600079	44,00	49,00	10,50
01500600080	45,00	50,00	12,50
00300700340	46,00	51,00	9,00
01500600081	46,00	51,00	12,50
01500600082	47,00	51,50	10,50
01500600083	48,00	52,50	10,50
01500600084	49,00	54,50	11,00
01500600085	50,00	54,00	10,00
01500600086	51,00	56,00	11,00
01500600087	52,00	57,50	11,00
01500600088	53,00	59,00	11,00
01500600089	54,00	61,00	11,00
01500600090	55,00	61,00	11,00
01500600091	56,00	63,00	12,00
01500600092	57,00	61,00	10,00
01500600093	58,00	65,00	11,00
00300700341	58,00	66,00	8,00
01500600094	59,00	65,00	11,00
01500600095	60,00	65,00	11,00
01500600096	61,00	67,50	11,00
01500600097	62,00	68,00	11,00
01500600098	63,00	66,50	12,50
01500600099	63,50	70,00	10,50
01500600100	64,00	67,50	9,50
01500600101	65,00	69,00	10,00
01500600102	66,00	71,00	12,00
01500600103	67,00	73,00	10,00

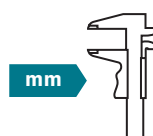
Color: Natural - Natural





PARA ROSCAS/FOR THREADS				
Referencia		MÉTRICA/METRIC	GAS/BSP	
Reference	Rosca normal/ Core thread	DIN ISO 13	DIN 259	DIN 2402
01500600069				
01500600070		M39x2,00		
01500600071				
01500600072	M42x4,50		M39x1,50	
01500600073				
01500600074		M42x3,00		R 1 1/4"
01500600075			M42x2,00	
00300700339	M45x4,50		M42x2,00	M42x1,50
01500600076	M45x4,50			M45x1,50
01500600077				
01500600078			M45x2,00	
01500600079	M48x5,00			
01500600080				
00300700340		M48x2,00		
01500600081		M48x2,00		R 1 1/2"
01500600082	M52x5,00			M48x1,50
01500600083		M52x3,00		
01500600084				
01500600085			M52x2,00	
01500600086	M56x5,50			M52x1,50
01500600087				
01500600088				
01500600089				M55x1,50
01500600090				M56x1,50
01500600091		M60x4,00		
01500600092			M60x2,00	M60x1,50
01500600093				
00300700341	M64x6,00	M62x4,00	M60x2,00	
01500600094				
01500600095				
01500600096				
01500600097				
01500600098				
01500600099				
01500600100				
01500600101				DN 65
01500600102				
01500600103				

Tapones y
Capuchones
Plugs & Caps

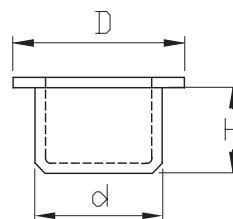
DTTZ
Tapón paralelo
Parallel plug

Material: LDPE / LLDPE
**Tapones y
Capuchones**
 Plugs & Caps

Referencia Reference	Para agujero (d) For hole (d)	D	H
01500600104	68,00	75,00	11,00
01500600105	69,00	75,00	10,50
01500600106	70,00	74,00	11,00
01500600107	71,00	77,00	11,00
01500600108	71,50	75,00	10,00
01500600109	72,00	79,00	12,00
00300700342	72,10	83,00	13,00
01500600110	73,00	76,50	9,50
01500600111	74,00	77,50	10,50
01500600112	75,00	79,00	9,50
01500600113	76,00	80,00	10,50
01500600114	77,00	81,00	9,50
01500600115	78,00	82,00	10,50
01500600116	79,00	86,00	13,50
01500600117	80,00	84,00	9,50
01500600118	81,00	85,00	9,50
01500600119	82,00	85,50	9,50
01500600120	83,00	86,50	9,50
01500600121	84,00	90,00	10,00
01500600122	84,50	90,00	8,00
01500600123	85,00	88,50	9,50
01500600124	86,00	90,00	9,50
01500600125	86,50	90,00	9,50
01500600126	87,00	90,50	9,50
01500600127	88,00	91,50	9,50
01500600128	89,00	92,50	9,50
01500600129	90,00	93,50	9,50
01500600130	92,00	95,50	9,50
01500600131	94,00	98,00	9,50
01500600132	96,00	104,00	13,50
00300700343	111,50	127,50	19,00
01500600133	184,00	194,00	16,00
01500600134	208,00	220,00	15,00
01500600135	233,00	245,00	16,00
01500600136	261,00	273,00	16,00
01500600137	285,00	295,00	18,00
01500600138	311,00	324,00	18,00

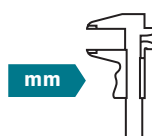
Color: Natural - Natural





**Tapones y
Capuchones**
Plugs & Caps

PARA ROSCAS/FOR THREADS				
Referencia		MÉTRICA/METRIC	GAS/BSP	
Reference	Rosca normal/ Core thread	DIN ISO 13	DIN 259	DIN 2402
01500600104				
01500600105				
01500600106				
01500600107				
01500600108				
01500600109				
00300700342		M76x4,00	M75x3,00	
01500600110				R 2 1/2"
01500600111				
01500600112				
01500600113				
01500600114				
01500600115				
01500600116				
01500600117				
01500600118				DN 80
01500600119				
01500600120				
01500600121				
01500600122				
01500600123				
01500600124				R 3"
01500600125				
01500600126				
01500600127				
01500600128				
01500600129				
01500600130				
01500600131				
01500600132				
00300700343				
01500600133				
01500600134				
01500600135				
01500600136				
01500600137				
01500600138				

PTRR

Tapón estriado con lengüeta Ribbed plug with tab

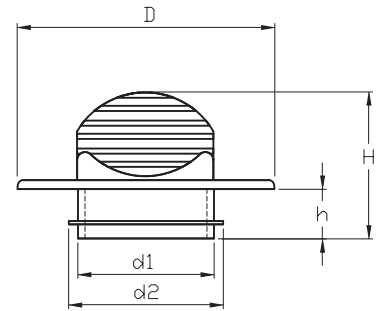

Material: LLDPE



RoHS

Tapones y
Capuchones
Plugs & Caps

Referencia Reference	D	d1	d2	h	H
01500600297	25,00	5,00	8,00	8,00	25,00
01500600298	27,00	7,00	10,00	8,00	25,00
01500600299	29,00	9,00	12,00	8,00	25,00
01500600300	31,00	11,00	14,00	8,00	25,00
01500600301	33,00	13,00	16,00	8,00	25,00
01500600302	35,00	15,00	18,00	8,00	25,00
01500600303	39,00	19,00	22,00	8,00	25,00
01500600304	43,00	23,00	26,00	8,00	25,00
01500600305	47,00	27,00	30,00	8,00	25,00
01500600306	49,00	29,00	32,00	8,00	25,00
01500600307	51,00	31,00	34,00	8,00	27,00
01500600308	58,00	38,00	41,00	8,00	27,00
01500600309	64,00	44,00	47,00	8,00	27,00
01500600310	75,00	55,00	58,00	8,00	27,00
01500600311	92,00	72,00	75,00	8,00	27,00
01500600312	99,00	79,00	82,00	8,00	27,00
01500600313	103,00	83,00	88,00	8,00	27,00

Color: Amarillo - Yellow

PARA ROSCAS / FOR THREADS

Referencia	MÉTRICA / METRIC		GAS / BSP	UN	UNC	UNF	UNEF
Reference	Rosca normal/ Core thread	DIN 13	DIN 259 / (DIN ISO 228)	ANSI/ASME / B1.a-1984			
01500600297	M8x1,25	M8x1,00	R 1/16"	5/16"		5/16"	5/16"
01500600298	M10x1,50	M10x1,00	R 1/8"	3/8"			3/8"
01500600299	M12x1,50	M12x1,00		1/2"	1/2"		
01500600300	M14x1,50	M14x1,00		9/16"		9/16"	9/16"
01500600301	M17x2,00	M16x1,50 M16x1,00	R 3/8"	5/8"			5/8"
01500600302		M19x2,00 M18x1,50	M18x1,00	11/16" / 3/4"			
01500600303	M24x3,00	M23x2,00 M22x1,50	M22x1,00	R 5/8"	7/8"		7/8"
01500600304		M23x2,00 M26x1,50	M26x1,00	R 3/4"	1" / 1 1/16" / 1 1/8"	1 1/8"	
01500600305		M32x3,00 M30x2,00	M30x1,00		1 3/16"		1 3/16"
01500600306		M34x3,00 M33x2,00	M32x1,00	R 1"	1 1/4"		
01500600307		M35x2,00	M34x1,00		1 3/8"	1 3/8"	
01500600308		M42x2,00		R 1 1/4"	1 5/8"		1 5/8"
01500600309		M48x2,00		R 1 1/2"	1 7/8"		
01500600310			M58x1,50	R 2"			
01500600311			M75x2 / M75x1	R 2 1/2"	3"		
01500600312			M82x1,00		3 1/4"		
01500600313		M88x3,00		R 3"			

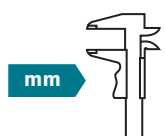

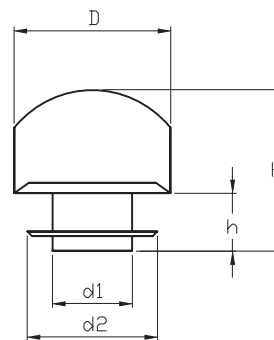
PTR**Tapón estriado con lengüeta**
Ribbed plug with tab

Material: LLDPE



RoHS

Referencia Reference	D	d1	d2	h	H
01500600288	15,80	8,00	12,90	5,80	16,00
01500600289	19,60	11,50	16,60	6,00	16,00
01500600290	22,60	15,50	21,30	7,90	18,00
01500600291	25,50	17,50	22,50	8,00	18,50
01500600292	27,50	20,00	24,00	8,90	20,90
01500600293	29,50	20,50	26,00	8,80	21,00
01500600294	34,30	22,50	27,20	9,00	21,00
01500600295	37,20	24,50	30,60	9,00	21,00
01500600296	43,20	28,00	34,00	10,00	23,00

Color: Amarillo - Yellow

Tapones y
Capuchones
Plugs & Caps**PARA ROSCAS/FOR THREADS**

Referencia	MÉTRICA/METRIC	PG	GAS/BSP	UN	UNC	UNF	UNEF
Reference	DIN 13	DIN 40430	DIN 259	ANSI/ASME			
	Rosca normal/ Core thread	(DIN ISO 228)			B1.a-1984		
01500600288	M12x1,75 / M14x2,00	M12x1 / M12x1,5 / M13x1 / M13x1,5 / M14x1,5	R 1/4"	1/2"	1/2"	1/2"	1/2"
01500600289	M16x2,00 / M18x1,25	M16x1 / M16x1,5	PG9	R 3/8"	9/16" / 5/8"	5/8"	9/16" / 5/8"
01500600290	M20x2,50 / M22x2,50	M18x1,5 / M20x1 / M20x1,5 / M20x2 / M21x1 / M21x1,5 / M21x2	R 1/2"	3/4" / 7/8"	3/4"	3/4" / 7/8"	3/4" / 13/16"
01500600291	M22x2,50	M22x1,5 / M22x2	R 5/8"	7/8"	7/8"	7/8"	7/8"
01500600292	M24x3,00	M24x1,5 M24x2	PG16	15/16"		15/16"	
01500600293	M27x3,00	M24x1,5 / M25x1,5 / M26x1,5	R 3/4"	1"	1"		1"
01500600294	M28x3,00	M28x1 / M28x1,5 / M28x2	PG21	1 1/16"		1 1/8"	
01500600295	M30x3,50	M30x1 / M30x1,5 / M30x2	R 7/8"	1 1/8"		1 3/16"	
01500600296	M36x4,00	M33x1,5 / M33x2	R 1"	1 3/16"			

mm



DPR Tapón estriado Ribbed plug

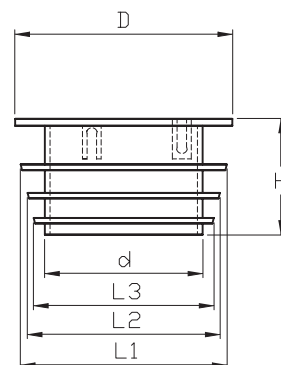

Material: LLDPE



RoHS

Tapones y
Capuchones
Plugs & Caps

Referencia Reference	A. Panel (Min-Máx) Hole Diam (Min-Max)	D	L1	L2	L3	d	H
01500500017	14,00 - 19,00	21,00	20,00	17,30	14,60	8,70	28,00
01500500018	18,00 - 25,00	24,30	25,30	22,20	20,00	15,00	28,00
01500500019	24,00 - 29,00	29,20	30,00	27,20	26,40	18,00	28,00
01500500020	28,00 - 37,00	37,30	38,00	34,60	32,00	22,50	32,00
01500500021	36,00 - 42,00	41,50	43,50	41,70	38,20	28,20	32,00
01500500022	42,00 - 50,00	49,50	50,30	47,60	43,60	34,50	32,00
01500500023	49,00 - 57,00	56,00	57,20	54,40	50,40	41,50	32,00
01500500024	55,00 - 63,00	62,50	63,50	59,00	55,50	47,20	32,00
01500500025	62,00 - 69,00	68,50	70,00	67,00	63,00	55,00	32,00
01500500026	69,00 - 75,00	75,00	75,50	73,00	69,00	60,00	32,00
01500500027	73,00 - 81,00	84,00	81,50	79,00	76,00	67,00	32,00
01500500028	82,00 - 88,00	87,90	88,50	85,50	80,50	73,00	32,00
01500500029	85,00 - 94,00	94,50	95,00	90,00	88,00	78,00	32,00
01500500030	93,00 - 101,00	100,00	102,00	98,00	93,50	85,00	32,00
01500500031	98,00 - 107,00	108,00	108,00	103,00	99,50	92,00	32,00
01500500032	90,00 - 110,00	113,00	112,00	--	112,00	80,00	38,00
01500500033	97,00 - 117,00	119,00	118,00	--	118,00	88,50	38,00
01500500034	102,00 - 123,00	125,00	124,00	--	124,00	92,00	38,00
01500500035	110,00 - 129,00	131,50	130,00	--	130,00	99,00	38,00
01500500036	113,00 - 133,00	138,50	134,00	--	134,00	102,00	38,00
01500500037	126,00 - 144,00	145,00	145,00	--	145,00	115,00	38,00
01500500038	132,00 - 148,00	153,00	153,00	--	151,00	122,50	38,00
01500500039	139,00 - 154,00	155,00	155,00	--	155,00	128,00	38,00
01500500040	145,00 - 161,00	162,00	162,00	--	162,00	134,00	38,00
01500500041	145,00 - 161,00	162,00	162,00	--	162,00	134,00	38,00
01500500042	157,00 - 175,00	176,00	176,00	--	176,00	146,00	38,00

Color: Azul - Blue

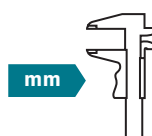

DT Tapón roscado con/sin junta tórica
Threaded plug with/without O-Ring

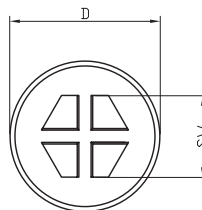
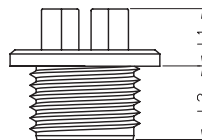

Material: PA6 / NBR RoHS

Rosca Métrica
Metric Thread

Referencia Reference	D	L2	L1	SW	DIN 13 / DIN ISO 6149-1
01500740455	15,40	8,00	15,00	7,00	M10x1,00
01500740456	18,40	9,00	16,00	10,00	M12x1,50
01500740457	20,40	9,00	17,00	10,00	M14x1,50
01500740458	23,40	10,00	20,00	13,00	M16x1,50
01500740459	25,40	11,00	21,00	13,00	M18x1,50
01500740460	28,40	12,00	22,00	15,00	M22x1,50
01500740461	33,30	15,00	25,00	19,00	M27x2,00
01500740462	36,00	15,00	25,00	24,00	M30x2,00
01500740463	42,30	15,00	25,00	24,00	M33x2,00
01500740464	44,00	15,00	25,00	24,00	M36x2,00
01500740465	51,30	15,00	26,00	24,00	M42x2,00
01500740466	55,00	15,00	26,00	30,00	M45x2,00
01500740467	56,30	17,00	28,00	30,00	M48x2,00
01500740468	60,00	17,00	28,00	30,00	M52x2,00

Rosca UN-UNF
UN-UNF Thread

Referencia Reference	D	L2	L1	SW	ISO 11926-1
01500740469	17,40	9,00	16,00	10,00	7/16" - 20
01500740470	21,40	10,00	18,00	10,00	9/16" - 18
01500740471	26,90	11,00	21,00	13,00	3/4" - 16
01500740472	30,40	13,00	23,00	15,00	7/8" - 14
01500740473	37,90	15,00	25,00	19,00	1 1/16" - 12
01500740474	44,80	15,00	25,00	24,00	1 5/16" - 12
01500740475	55,80	15,00	26,00	30,00	1 5/8" - 16
01500740476	63,30	15,00	26,00	30,00	1 7/8" - 12

Color: Natural / Amarillo - Natural / Yellow

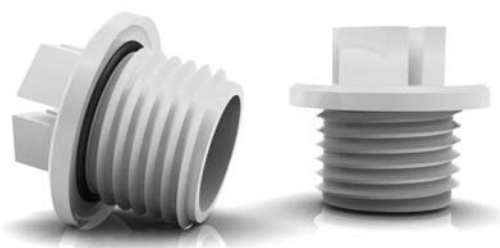

Tapones y
Capuchones
Plugs & Caps

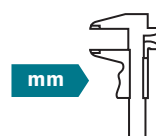

DTRO-DTRU

Tapón roscado con/sin junta tórica Threaded plug with/without O-Ring

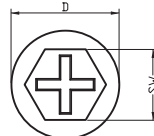
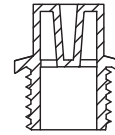
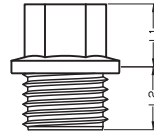

Material: PA6 / HDPE / NBR



TIPO/TYPE 1

TIPO/TYPE 2

Rosca Métrica

Metric Thread

Referencia Reference	D	L2	L1	SW	Tipo Type	DIN 13 / DIN ISO 6149-1
01500740001	14,20	7,00	10,00	10,00	2	M10x1,00
01500740047	17,20	10,00	10,00	13,00	1	M12x1,50
01500740048	19,20	10,00	10,00	13,00	1	M14x1,50
01500740049	22,00	10,00	10,00	17,00	1	M16x1,50
01500740050	24,00	10,00	11,00	17,00	1	M18x1,50
01500740051	26,00	10,00	14,00	19,00	1	M20x1,50
01500740052	27,20	10,00	14,00	19,00	1	M22x1,50
01500740053	31,50	12,00	14,00	24,00	1	M24x1,50
01500740054	32,00	10,00	14,00	24,00	1	M26x1,50
01500740055	32,30	13,00	14,00	24,00	1	M27x2,00
01500740056	40,40	13,00	14,00	27,00	2	M33x2,00
01500740057	50,00	13,00	15,00	36,00	2	M42x2,00

Rosca GAS-BSP

GAS-BSP Thread

Referencia Reference	D	L2	L1	SW	Tipo Type	DIN 259 / DIN ISO 228
01500740058	16,80	9,00	10,00	13,00	1	R 1/8"
01500740059	19,20	9,00	10,00	13,00	1	R 1/4"
01500740060	22,20	9,00	11,00	17,00	1	R 3/8"
01500740061	27,20	12,00	13,00	19,00	1	R 1/2"
01500740062	32,30	12,00	13,00	24,00	1	R 3/4"
01500740063	40,00	15,00	14,00	27,00	2	R 1"
01500740064	50,40	15,00	15,00	36,00	2	R 1 1/4"
01500740065	55,40	15,00	15,00	41,00	2	R 1 1/2"
01500740066	68,40	15,00	15,00	55,00	2	R 2"

Rosca UN-UNF

UN-UNF Thread

Referencia Reference	D	L2	L1	SW	Tipo Type	ISO 11926-1
01500740067	20,80	11,00	9,00	13,00	1	7/16" - 20
01500740068	22,80	11,00	10,00	13,00	1	1/2" - 20
01500740070	24,80	12,00	12,00	17,00	1	5/8" - 18
01500740069	24,80	11,00	10,00	13,00	1	9/16" - 18
01500740071	26,00	10,00	13,00	17,00	1	3/4" - 16
01500740072	33,80	14,00	12,00	19,00	1	7/8" - 14
01500740073	40,80	14,00	12,00	24,00	1	1 1/16" - 12
01500740074	42,00	15,00	15,00	27,00	1	1 5/16" - 12
01500740076	57,80	17,00	15,00	36,00	1	1 5/8" - 16
01500740075	58,70	17,00	15,00	36,00	1	1 5/8" - 12

Color: Amarillo / Rojo - Yellow / Red

mm



DTY Tapón roscado Threaded plug

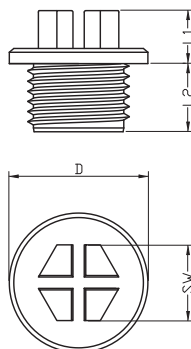

Material: PA6



Rosca Métrica

Metric Thread

Referencia Reference	D	L2	L1	SW	DIN 13 / DIN ISO 6149-1
01500500104	14,20	8,00	15,00	7,00	M10x1,00
01500500105	17,20	11,00	18,00	10,00	M12x1,50
01500500106	19,20	11,00	19,00	10,00	M14x1,50
01500500107	22,00	11,00	21,00	13,00	M16x1,50
01500500108	24,00	11,00	21,00	13,00	M18x1,50
01500500109	26,00	11,00	21,00	15,00	M20x1,50
01500500110	27,20	11,00	21,00	15,00	M22x2,00
01500500111	32,00	13,50	23,50	19,00	M26x2,00
01500500112	32,30	11,00	21,00	19,00	M27x2,00
01500500113	40,40	13,50	23,50	24,00	M33x2,00
01500500114	50,00	13,50	23,50	24,00	M42x2,00
01500500115	55,40	13,50	24,50	30,00	M48x2,00
01500500116	68,50	13,50	24,50	30,00	M60x2,00

Rosca GAS-BSP

GAS-BSP Thread

Referencia Reference	D	L2	L1	SW	DIN 259 / DIN ISO 228
01500500117	19,20	7,50	15,50	10,00	R 1/4"
01500500118	22,20	7,50	17,50	13,00	R 3/8"
01500500119	27,20	9,50	19,50	15,00	R 1/2"
01500500120	32,30	9,50	19,50	19,00	R 3/4"
01500500121	40,00	9,50	21,50	24,00	R 1"
01500500122	50,40	11,50	22,50	24,00	R 1 1/4"
01500500123	55,40	11,50	22,50	30,00	R 1 1/2"

Rosca UNF

UNF Thread

Referencia Reference	D	L2	L1	SW	ISO 11926-1
01500500124	17,80	11,00	18,00	10,00	9/16" - 18

Color: Natural / Amarillo - Natural / Yellow

Tapones y
Capuchones
Plugs & Caps

PRTH Tapón roscado Threaded plug

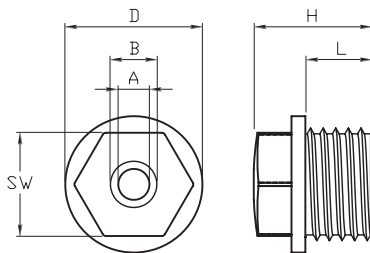
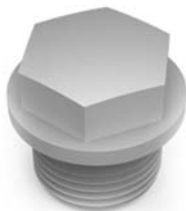

Material: LLDPE



Rosca Métrica

Metric Thread

Referencia Reference	Rango Cable Cable Range	D	A	B	L	H	SW	
01500800116	5,00 - 10,00	19,80	4,50	-	9,50	17,00	15,00	M16x1,50
01500800117	8,00 - 13,50	24,00	7,00	-	12,00	20,00	19,00	M20x1,50
01500800118	9,00 - 16,00	29,50	8,00	-	12,00	22,00	24,00	M25x1,50
01500800119	11,00 - 22,00	37,50	15,00	-	14,00	25,00	30,00	M32x1,50
01500800120	17,00 - 24,00	45,80	20,00	-	16,00	29,00	37,00	M40x1,50
01500800121	22,00 - 35,00	55,80	22,00	28,00	28,00	32,00	46,00	M50x1,50
01500800122	24,00 - 43,00	68,80	22,00	33,00	20,00	38,00	56,00	M63x1,50

Rosca PG

PG Thread

Referencia Reference	Rango Cable Cable Range	D	A	B	L	H	SW	
01500800123	7,00 - 10,00	20,20	7,00	-	11,00	19,50	17,00	PG13
01500800124	7,00 - 10,00	22,50	7,00	-	11,00	18,50	19,00	PG16

Color: Gris / Negro - Grey / Black

PTG Tapón roscado Threaded plug

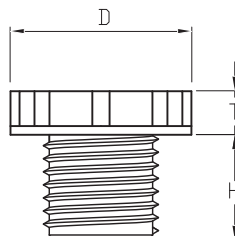

Material: LLDPE



Rosca Métrica

Metric Thread

Referencia Reference	D	H	T	DIN 13 / DIN ISO 6149-1
01500600314	21,00	9,00	5,00	M12 x 1,50
01500600315	21,00	9,00	5,00	M14 x 1,50
01500600316	23,00	10,00	6,00	M16 x 1,50
01500600317	23,00	10,00	6,00	M18 x 1,50
01500600318	28,00	12,00	6,00	M20 x 1,50
01500600319	28,00	12,00	6,00	M22 x 1,50

Rosca GAS-BSP

GAS-BSP Thread

Referencia Reference	D	H	T	DIN 259 / DIN ISO 228
01500600320	21,00	9,00	5,00	R 1/8"
01500600321	21,00	9,00	5,00	R 1/4"
01500600322	23,00	10,00	6,00	R 3/8"
01500600323	28,00	12,00	6,00	R 1/2"

Color: Amarillo - Yellow

mm



PRT Tapón roscado
Threaded plug

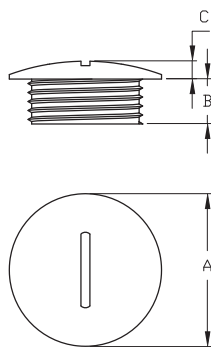

Material: PS

RoHS

EN 60 529: IP54

Rosca Métrica

Metric Thread

Referencia Reference	A	B	C	
01500900001	15,00	6,00	4,00	M12x1,50
01500900002	20,00	7,00	4,00	M16x1,50
01500900003	24,00	7,00	4,50	M20x1,50
01500900004	30,00	11,00	4,50	M25x1,50
01500900005	38,00	11,00	5,00	M32x1,50
01500900006	46,00	13,00	5,00	M40x1,50
01500900007	56,00	14,00	6,50	M50x1,50
01500900008	69,00	15,00	5,50	M63x1,50

Rosca PG

PG Thread

Referencia Reference	A	B	C	DIN 46 320
01500900017	15,00	6,00	2,00	PG7
01500900018	19,00	6,00	3,00	PG9
01500900009	22,00	6,00	3,00	PG11
01500900010	25,00	6,00	3,50	PG13,5
01500900011	27,00	6,00	3,50	PG16
01500900012	33,00	8,00	3,00	PG21
01500900013	44,00	8,00	4,00	PG29
01500900014	55,00	10,00	5,00	PG36
01500900015	62,00	10,00	6,00	PG42
01500900016	69,00	12,00	4,00	PG48

Color: Gris / Negro - Grey / Black

Tapones y
Capuchones
Plugs & Caps

mm



PRTT

Tapón roscado Threaded plug

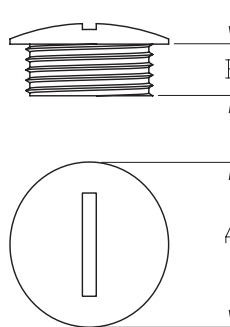

Material: NB



EN 60 529: IP54

Rosca Métrica

Metric Thread

Referencia Reference	A	B	
01500600498	16,00	5,00	M12
01500600499	20,00	6,00	M16
01500600500	24,00	6,50	M20
01500600501	28,00	7,00	M25
01500600502	35,00	8,00	M32
01500600503	45,00	8,00	M40
01500600504	55,00	9,00	M50
01500600505	68,00	10,00	M63

Rosca PG

PG Thread

Referencia Reference	A	B	DIN 46 320
01500600506	14,00	5,00	PG7
01500600507	17,00	6,00	PG9
01500600508	20,00	6,00	PG11
01500600509	22,00	6,50	PG13
01500600510	24,00	6,50	PG16
01500600511	30,00	7,00	PG21
01500600512	39,00	8,00	PG29
01500600513	50,00	9,00	PG36
01500600514	57,00	10,00	PG42
01500600515	64,00	10,00	PG48

Color: Acerado - Steel

Tapones y
Capuchones
Plugs & Caps



DTSI Tapón macizo cónico
Solid protection plug



Material: SI / EPDM **RoHS**

Rosca Métrica

Metric Thread

Referencia Reference	B	A	C	
02100100001	0,38	2,03	50,80	M2
02100100002	0,79	2,54	25,40	M2
02100100003	0,79	3,18	15,88	M2-M3
02100100004	1,57	3,18	15,88	M3
02100100005	1,57	5,08	12,70	M3-M4
02100100006	1,57	5,08	15,88	M3-M4
02100100007	1,57	5,08	19,05	M3-M4
02100100008	1,59	4,76	15,88	M3-M4
02100100009	3,18	6,35	19,05	M5-M6
02100100010	3,18	6,35	25,40	M5-M6
02100100011	3,18	12,70	50,80	M5-M12
02100100012	4,75	8,74	15,88	M6-M8
02100100013	4,75	8,74	25,40	M6-M8
02100100014	6,35	9,53	12,70	M8-M10
02100100015	6,35	9,53	19,05	M8-M10
02100100017	7,62	12,70	19,05	M10-M12
02100100018	7,95	12,70	20,65	M12
02100100019	8,73	11,11	17,46	M12
02100100020	9,53	14,29	25,40	M14
02100100021	10,31	15,09	25,40	M14-M16
02100100022	11,11	15,88	20,64	M14-M16
02100100023	12,70	16,66	25,40	M16
02100100024	14,30	19,05	25,40	M18-M20
02100100025	15,88	19,81	25,40	M20

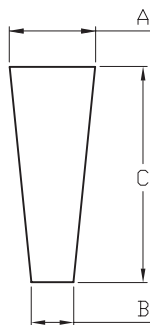

Rosca Métrica

Metric Thread

Referencia Reference	B	A	C	
02100100026	18,26	23,83	25,40	M22-M24
02100100027	19,05	25,40	25,40	M22-M24
02100100028	23,01	27,00	25,40	M27
02100100029	24,36	30,23	25,40	
02100100030	26,19	31,75	25,40	M33
02100100031	27,00	34,14	25,40	M33
02100100032	28,58	36,53	25,40	M36
02100100033	30,15	38,10	25,40	
02100100034	33,35	41,28	25,40	M39-M42
02100100035	35,71	42,88	25,40	M42
02100100036	37,31	44,45	25,40	M45
02100100037	38,10	46,05	25,40	
02100100038	41,28	50,01	25,40	
02100100039	44,45	52,78	25,40	
02100100040	47,63	55,96	25,40	M56
02100100041	50,80	62,71	25,40	M64
02100100042	53,98	63,50	25,40	M64
02100100043	57,94	68,28	25,40	
02100100044	61,93	75,01	34,93	
02100100045	61,93	75,41	35,56	
02100100046	76,20	88,90	38,10	
02100100047	82,55	101,60	38,10	
02100100048	88,90	127,00	50,80	

Tapones y
Capuchones
Plugs & Caps

Color: Natural / Negro / Azul / Azul claro / Rojo óxido / Verde / Gris / Rosa / Blanco / Amarillo
Natural / Black / Blue / Light blue / Rusty red / Green / Grey / Pink / White / Yellow

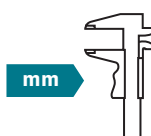

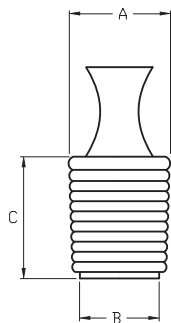
PLE
Tapón cónico estriado
Conical ribbed plug

Material: SI / EPDM



ROSCA MÉTRICA

METRIC THREAD

Referencia Reference	B	A	C	DIN 13
02100100714	3,99	5,84	25,40	M5-M6
02100100715	5,61	8,00	25,40	M8
02100100716	8,00	9,65	25,40	M10
02100100717	9,65	11,94	25,40	M12
02100100718	12,19	14,61	25,40	M14
02100100719	13,61	16,00	25,40	M16
02100100720	16,00	18,01	25,40	M18
02100100721	18,01	19,99	25,40	M20
02100100722	19,99	22,00	25,40	M22
02100100723	22,00	24,00	25,40	M24
02100100724	24,00	26,01	25,40	M26
02100100725	26,01	27,99	25,40	M28

Color: Natural / Negro / Azul claro / Rojo óxido / Verde claro / Verde oscuro / Gris / Amarillo / Lila

Natural / Black / Light blue / Rusty red / Light green / Dark green / Grey / Yellow / Lilac

Silicona / Silicone



DTHSE



DCCR



DCR



DCRA



DTR



PLM



PLLL



PVS



DCC



PLTA



PLTB



PLTC



PLTD



PLTE



PLTF



PLTG



ATFA



MTS

Tapones y
Capuchones
Plugs & Caps

Más diseños y medidas disponibles en nuestro catálogo online, consulte en www.isc-sl.com
More designs and sizes available on our online catalogue, visit www.isc-sl.com



DCSI Capuchón protector paralelo Parallel protection cap

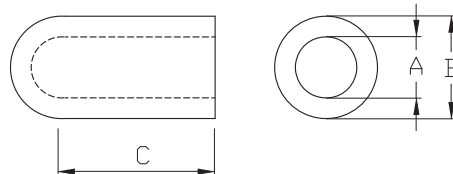

Material: SI / EPDM RoHS

Rosca Métrica

Metric Thread

Rosca Métrica

Metric Thread

Tapones y
Capuchones
Plugs & Caps

Referencia Reference	A	B	C	DIN 13
02100100100	0,51	3,56	6,35	
02100100101	0,51	3,56	12,70	
02100100102	0,94	2,54	12,70	
02100100103	1,02	4,06	19,05	
02100100104	1,57	4,62	6,35	
02100100105	1,57	4,62	19,05	
02100100106	1,57	4,62	25,40	
02100100108	1,78	4,83	25,40	
02100100107	1,78	4,93	6,35	
02100100110	2,36	4,95	12,70	
02100100109	2,36	5,41	6,35	
02100100111	2,36	5,41	19,05	
02100100112	2,36	5,41	25,40	
02100100113	2,54	5,59	12,70	M3
02100100114	2,54	5,59	25,40	
02100100115	2,54	5,59	38,10	
02100100116	2,77	5,82	12,70	
02100100117	2,77	5,82	19,05	
02100100118	2,77	5,82	25,40	
02100100119	3,18	6,22	12,70	
02100100120	3,18	6,22	25,40	
02100100121	3,48	6,53	12,70	
02100100122	3,48	6,53	25,40	
02100100123	3,56	6,73	12,70	M4
02100100124	3,56	6,73	25,40	
02100100125	3,76	6,10	19,05	
02100100126	3,76	6,81	25,40	
02100100127	3,96	7,01	12,70	
02100100128	3,96	7,01	25,40	
02100100129	4,17	7,42	25,40	
02100100130	4,37	7,42	12,70	
02100100131	4,37	7,42	25,40	
02100100132	4,37	7,42	38,10	
02100100133	4,57	7,11	25,40	M5
02100100134	4,75	7,80	12,70	
02100100135	4,75	7,80	25,40	
02100100136	5,54	8,59	25,40	M6
02100100137	5,66	8,71	12,70	
02100100138	5,66	8,71	25,40	

Referencia Reference	A	B	C	DIN 13
02100100139	5,66	8,71	38,10	
02100100141	5,94	8,99	19,05	
02100100142	5,94	8,99	25,40	
02100100143	5,94	8,99	38,10	
02100100140	5,94	9,10	12,70	
02100100145	6,35	9,40	25,40	
02100100146	6,35	9,40	38,10	
02100100144	6,35	9,70	12,70	
02100100147	7,14	10,19	12,70	
02100100148	7,14	10,19	25,40	
02100100151	7,49	10,54	38,10	
02100100150	7,49	10,67	25,40	
02100100149	7,49	10,70	12,70	M8
02100100152	7,92	10,97	25,40	
02100100153	7,92	10,97	38,10	
02100100154	8,64	11,68	25,40	
02100100155	8,71	11,76	25,40	
02100100156	9,02	12,07	14,99	
02100100157	9,02	12,07	38,10	
02100100160	9,53	12,57	25,40	
02100100161	9,53	12,57	38,10	
02100100158	9,53	12,83	12,70	M10
02100100159	9,53	12,83	19,05	
02100100162	10,31	13,36	25,40	
02100100163	11,10	14,15	25,40	
02100100164	11,58	14,63	25,40	M12
02100100165	11,58	14,63	38,10	
02100100166	11,89	14,93	25,40	
02100100167	11,89	14,94	38,10	
02100100169	12,19	15,24	38,10	
02100100168	12,20	15,40	25,40	
02100100170	12,70	15,75	38,10	
02100100171	12,70	15,75	44,45	
02100100172	12,70	15,75	57,15	
02100100173	12,70	15,75	101,60	
02100100174	13,59	16,64	38,10	M14
02100100175	13,59	16,64	76,20	
02100100176	14,27	17,32	38,10	
02100100177	15,24	18,29	38,10	M16

Color: Natural / Negro / Azul oscuro / Azul claro / Verde claro / Verde oscuro / Gris / Amarillo / Rosa / Blanco

Natural / Black / Dark blue / Light Blue / Light green / Dark green / Grey / Yellow / Pink / White

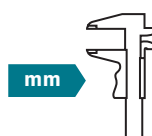

DCSI Capuchón protector paralelo

Parallel protection cap

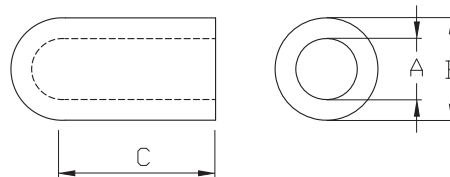

Material: SI / EPDM



Rosca Métrica

Metric Thread

Rosca Métrica

Metric Thread

Referencia Reference	A	B	C	DIN 13
02100100178	15,88	18,92	31,75	
02100100179	15,88	18,92	38,10	
02100100180	15,88	18,92	63,50	
02100100181	17,45	20,50	38,10	M18
02100100182	17,45	20,50	44,45	
02100100183	18,54	21,59	38,10	
02100100184	18,54	21,59	109,86	
02100100185	19,05	22,10	38,10	M20
02100100186	19,05	22,10	50,80	
02100100187	19,05	22,10	88,90	
02100100188	19,81	23,00	38,10	
02100100189	20,62	23,67	38,10	M22
02100100190	20,62	23,67	44,45	
02100100191	22,23	25,27	17,15	
02100100192	22,23	25,27	38,10	
02100100193	22,23	25,27	76,20	
02100100194	23,80	26,85	38,10	M24
02100100196	24,64	27,69	101,60	
02100100195	24,64	27,81	38,10	
02100100197	25,40	28,45	38,10	
02100100198	25,40	28,45	50,80	
02100100199	26,97	30,02	38,10	
02100100201	26,97	30,02	76,20	

Referencia Reference	A	B	C	DIN 13
02100100200	26,97	30,10	50,80	
02100100202	28,58	31,62	38,10	M30
02100100203	28,58	31,62	114,30	
02100100204	30,15	33,20	38,10	
02100100205	31,75	34,80	38,10	
02100100206	34,29	37,34	38,10	M36
02100100207	34,93	37,97	38,10	
02100100209	38,10	41,15	38,10	
02100100210	38,10	41,28	44,45	
02100100208	38,10	41,30	25,40	
02100100211	41,28	44,32	38,10	
02100100212	44,45	47,50	38,10	
02100100214	44,45	47,50	63,50	
02100100213	44,45	47,60	50,80	
02100100215	47,63	50,67	38,10	
02100100216	47,63	50,80	50,80	
02100100217	50,80	53,85	50,80	
02100100218	63,50	66,55	38,10	
02100100219	69,85	72,90	38,10	
02100100220	88,90	91,95	38,10	
02100100221	88,90	91,95	76,20	
02100100222	101,60	104,65	44,45	

Tapones y
Capuchones
Plugs & Caps

Color: Natural / Negro / Azul oscuro / Azul claro / Verde claro / Verde oscuro / Gris / Amarillo / Rosa / Blanco
Natural / Black / Dark blue / Light blue / Light green / Dark green / Grey / Yellow / Pink / White



DCRO Capuchón roscado Threaded cap

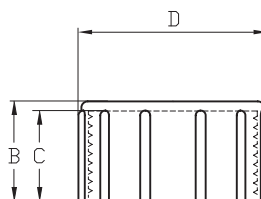

Material: LLDPE



Rosca Métrica

Metric Thread

Referencia Reference	D	C	B	DIN 13 / DIN ISO 6149-1
01500601557	12,00	11,00	12,00	M8 x 1,00
01500601558	14,20	12,90	14,20	M10 x 1,00
01500601559	16,40	12,70	14,20	M12 x 1,00
01500601560	16,40	12,70	14,20	M12 x 1,50
01500601561	18,20	12,80	14,10	M14 x 1,50
01500601562	20,00	12,80	14,20	M16 x 1,50
01500601563	22,00	13,80	15,20	M18 x 1,50
01500601564	24,20	14,60	16,10	M20 x 1,50
01500601565	26,50	14,70	16,20	M22 x 1,50
01500601566	28,60	14,70	16,20	M24 x 1,50
01500601567	30,80	13,50	15,30	M26 x 1,50
01500601568	32,00	13,50	15,30	M27 x 2,00
01500601569	35,00	14,50	16,30	M30 x 1,50
01500601570	35,00	14,50	16,20	M30 x 2,00
01500601571	42,00	16,80	18,60	M36 x 1,50
01500601572	42,00	16,80	18,60	M36 x 2,00
01500601573	50,00	15,70	17,70	M42 x 2,00
01500601574	51,00	18,70	20,30	M45 x 1,50
01500601575	51,00	18,70	20,30	M45 x 2,00
01500601576	59,00	19,00	20,50	M52 x 2,00

Rosca GAS-BSP

GAS-BSP Thread

Referencia Reference	D	C	B	DIN 259 / DIN ISO 228
01500601577	12,90	11,00	12,20	R 1/8"
01500601578	16,00	12,00	13,00	R 1/4"
01500601579	20,50	13,10	14,40	R 3/8"
01500601580	24,80	14,00	15,40	R 1/2"
01500601581	28,00	14,00	15,50	R 5/8"
01500601582	30,50	15,10	16,50	R 3/4"
01500601583	39,00	18,00	19,50	R 1"
01500601584	47,00	15,80	17,30	R 1 1/4"
01500601585	55,60	16,70	18,30	R 1 1/2"
01500601586	67,30	17,90	19,30	R 2"

Color: Amarillo - Yellow

Tapones y
Capuchones
Plugs & Caps



DCRO Capuchón roscado
Threaded cap

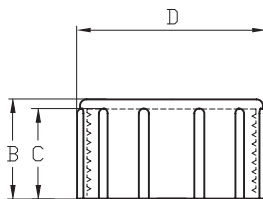

Material: LLDPE



Rosca UN/UNF
UN/UNF Thread

Referencia Reference	D	C	B	ISO 11926-1
01500601543	13,60	11,30	12,50	3/8-24
01500601544	15,60	11,90	13,30	7/16-20
01500601545	17,00	14,10	15,30	1/2-20
01500601546	18,70	12,50	13,90	9/16-18
01500601547	20,30	18,00	19,40	5/8-18
01500601548	23,60	17,60	19,20	3/4-16
01500601549	21,20	14,20	15,50	11/16-16
01500601550	24,70	14,20	15,50	13/16-16
01500601551	27,00	19,50	21,20	7/8-14
01500601552	30,00	16,10	17,30	1-14
01500601553	31,70	20,10	21,70	1 1/16-12
01500601554	35,00	21,10	22,70	1 3/16-12
01500601555	39,30	21,10	22,90	1 5/16-12
01500601556	44,00	21,00	22,80	1 7/16-12

Color: Amarillo - Yellow

Tapones y
Capuchones
Plugs & Caps



DCROA Capuchón roscado con/sin junta plana

Threaded cap with/without seal

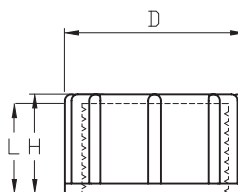

Material: HDPE / NBR RoHS

Rosca Métrica

Metric Thread

Referencia Reference	D	L	H	DIN 13 / DIN ISO 6149-1
01500601596	14,00	8,00	9,00	M10 x 1,00
01500601597	16,00	12,00	13,50	M12 x 1,50
01500601598	18,00	12,00	13,50	M14 x 1,50
01500601599	21,00	12,00	13,50	M16 x 1,50
01500601600	22,00	12,00	13,50	M18 x 1,50
01500601601	25,00	14,00	15,50	M20 x 1,50
01500601602	28,00	14,00	15,50	M22 x 1,50
01500601603	30,00	14,00	15,50	M24 x 1,50
01500601604	34,00	11,00	13,00	M26 x 1,50
01500601605	38,00	14,00	16,00	M30 x 2,00
01500601606	44,00	17,00	19,00	M36 x 2,00
01500601607	50,00	15,00	17,00	M42 x 2,00
01500601608	53,00	15,00	17,00	M45 x 2,00
01500601609	60,00	15,00	17,00	M52 x 2,00

Rosca GAS-BSP

GAS-BSP Thread

Referencia Reference	D	L	H	DIN 259 / DIN ISO 228
01500601610	18,00	12,00	13,50	R 1/4"
01500601611	21,00	12,00	13,50	R 3/8"
01500601612	25,00	14,00	15,50	R 1/2"
01500601613	28,00	14,00	15,50	R 5/8"
01500601614	32,00	14,00	16,00	R 3/4"
01500601615	39,00	14,00	16,00	R 1"
01500601616	47,70	17,70	19,70	R 1 1/4"
01500601617	56,00	17,00	19,00	R 1 1/2"
01500601618	68,00	18,00	20,00	R 2"

Rosca UN-UNF

UN-UNF Thread

Referencia Reference	D	L	H	ISO 11926-1
01500601587	15,00	12,00	13,50	7/16-20
01500601589	18,00	12,00	13,50	9/16-18
01500601588	18,00	15,00	16,50	1/2-20
01500601590	19,30	14,20	15,00	5/8-18
01500601591	24,00	18,00	19,50	3/4-16
01500601592	27,00	20,00	21,50	7/8-14
01500601593	34,00	23,00	25,00	1 1/16-12
01500601594	40,00	24,00	26,00	1 5/16-12
01500601595	50,00	17,00	19,00	1 5/8-12

Color: Amarillo - Yellow

Tapones y
Capuchones
Plugs & Caps

mm



LSKS

Capuchón protector rosca-tubo

Protector cap for threads and tubes

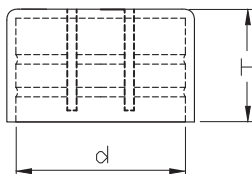

Material: LDPE

RoHS

PARA ROSCAS/FOR THREADS

PARA TUBOS/FOR TUBES

MÉTRICA/METRIC

GAS/BSP

Referencia Reference	d	H	PARA ROSCAS/FOR THREADS		
			DIN 13	DIN 259	DIN 2448/2458
00300401173	5,70	12,00	M6	--	--
00300401174	7,80	14,30	M8	--	5/16"
00300401175	9,80	11,00	M10	R 1/8"	13/32"
00300401176	10,20	8,00	--	--	--
00300401177	10,50	8,00	--	--	--
00300401178	11,50	12,00	M12	--	15/32"
00300401179	12,70	13,50	--	R 1/4"	--
00300401180	12,70	18,00	--	R 1/4"	--
00300401181	13,50	13,50	M14	--	17/32"
00300401182	15,70	15,00	M16	--	5/8"
00300401183	15,70	22,80	M16	--	5/8"
00300401184	15,90	14,00	--	R 3/8"	11/16"
00300401185	17,70	15,00	M18	--	23/32"
00300401186	19,70	14,00	M20	--	25/32"
00300401187	20,60	15,00	--	R 1/2"	27/32"
00300401188	21,30	15,50	M22	--	7/8"
00300401189	23,50	18,50	M24	--	15/16"
00300401190	25,40	17,50	M26	--	--
00300401191	26,20	18,50	--	R 3/4"	11/16"
00300401192	29,30	18,00	M30	--	--
00300401193	33,40	22,50	--	R 1"	1 11/32"
00300401194	33,40	45,00	--	R 1"	1 11/32"
00300401195	34,80	25,00	--	--	--
00300401196	35,70	14,00	--	--	--
00300401197	37,50	20,00	--	--	1 1/2"
00300401198	41,90	28,00	--	R 1 1/2"	1 11/16"
00300401199	47,80	29,50	--	R 1 1/2"	1 29/32"
00300401200	51,60	16,00	--	--	--
00300401201	52,50	30,00	--	R 1 3/4"	--
00300401202	56,70	19,00	--	--	2 1/4"
00300401203	59,70	30,00	--	R 2"	2 3/8"
00300401204	59,70	-	--	R 2"	2 3/8"
00300401205	69,80	25,00	--	--	2 1/4"
00300401206	75,50	35,00	--	R 2 1/2"	--
00300401207	75,80	18,00	--	--	3"
00300401208	79,80	25,00	--	--	--
00300401209	88,40	36,00	--	R 3"	--
00300401210	108,80	-	--	--	4"

Tapones y
Capuchones
Plugs & Caps

Color: Natural - Natural

mm



LSKC

Capuchón protector con lengüeta Tear-off cap

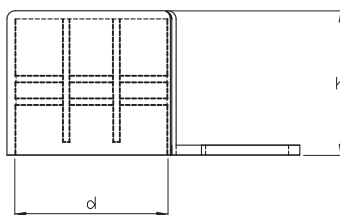

Material: LDPE



PARA ROSCAS/FOR THREADS

PARA TUBOS/FOR TUBES

MÉTRICA/METRIC

GAS/BSP

Referencia Reference	d	h	PARA ROSCAS/FOR THREADS		
			MÉTRICA/METRIC DIN 13	GAS/BSP DIN 259	PARA TUBOS/FOR TUBES DIN 2448/2458
00300401211	9,80	11,25	M10	R 1/8"	13/32"
00300401212	11,50	12,00	M12	--	15/32"
00300401213	13,10	13,50	--	R 1/4"	--
00300401214	13,50	13,50	M14	--	17/32"
00300401215	15,70	15,00	M16	--	5/8"
00300401216	16,80	14,80	--	R 3/8"	11/16"
00300401217	17,65	14,50	M18	--	23/32"
00300401218	21,10	15,00	M20	R 1/2"	25/32"
00300401219	21,30	15,50	M22	R 5/8"	7/8"
00300401220	26,30	18,50	--	R 3/4"	11/16"
00300401221	33,40	22,50	--	R 1"	1 11/32"

Color: Natural - Natural

DCTU Capuchón protector rosca-tubo Protector cap for threads and tubes

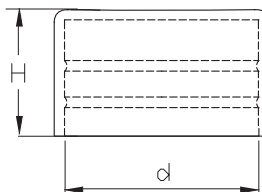

Material: LLDPE	RoHS	Tamaño tubo / Tube size	
		GAS/BSP	
Referencia Reference	d	H	DIN 259 / DIN 2999
01500701060	4,00	22,00	--
01500701061	5,00	18,00	--
01500701062	6,00	18,00	--
01500701063	6,35	22,00	--
01500701064	7,00	18,00	--
01500701065	8,00	17,00	--
01500701066	9,60	14,00	--
01500701067	10,20	18,00	1/8"
01500701068	11,00	19,00	--
01500701069	12,00	18,00	--
01500701070	12,70	19,00	--
01500701071	13,00	18,00	--
01500701072	13,70	18,00	1/4"
01500701073	14,00	18,00	--
01500701074	15,00	19,00	--
01500701075	16,00	20,00	--
01500701076	17,20	20,00	3/8"
01500701077	18,00	18,00	--
01500701078	19,00	20,00	--
01500701079	20,00	20,00	--
01500701080	21,30	20,00	DN15 - 1/2"
01500701081	22,00	21,00	--
01500701082	23,20	19,00	--
01500701083	24,00	18,00	--
01500701084	24,80	17,00	--
01500701085	25,00	80,00	--
01500701086	25,40	20,00	--
01500701087	26,00	18,00	--
01500701088	26,90	27,00	DN20 - 3/4"
01500600287	26,90	80,00	--
01500701089	28,00	22,00	--
01500701090	30,00	27,50	--
01500701091	31,80	27,00	--
01500701092	31,80	90,00	--
01500701093	33,70	23,00	DN25 - 1"
01500701094	35,00	27,00	--
01500701095	38,10	27,00	--
01500701096	38,10	90,00	--

Material: LLDPE	RoHS	Tamaño tubo / Tube size	
		GAS/BSP	
Referencia Reference	d	H	DIN 259 / DIN 2999
01500701097	39,00	17,00	--
01500701098	40,00	27,00	--
01500701099	41,50	25,00	--
01500701100	42,40	32,00	DN32 - 1 1/4"
01500701101	42,40	80,00	--
01500701102	44,50	35,00	--
01500701103	44,50	80,00	--
01500701104	45,40	20,00	--
01500701105	48,30	32,00	DN40 - 1 1/2"
01500701106	50,80	27,00	--
01500701107	51,00	90,00	--
01500701108	52,00	33,00	--
01500701109	52,80	28,00	--
01500701110	54,00	35,00	1 3/4"
01500701111	55,00	29,00	--
01500701112	57,00	35,00	--
01500701113	57,00	80,00	--
01500701114	59,00	30,00	--
01500701115	60,30	32,00	DN50 - 2"
01500701116	63,50	32,00	--
01500701117	63,50	90,00	--
01500701118	65,00	30,00	--
01500701119	66,50	35,00	--
01500701120	67,00	36,00	--
01500701121	70,00	30,00	--
01500701122	73,00	37,00	--
01500701123	75,00	38,00	--
01500701124	76,10	32,00	DN65 - 2 1/2"
01500701125	77,00	35,00	--
01500701126	78,00	26,00	--
01500701127	79,40	26,00	--
01500701128	81,00	30,00	--
01500701129	82,50	30,00	--
01500701130	83,00	30,00	2 3/4"
01500701131	85,00	30,00	--
01500701132	88,90	32,00	DN80 - 3"
01500701133	88,90	90,00	--
01500701134	90,00	90,00	--

Tapones y
Capuchones
Plugs & Caps

Color: Amarillo / Natural / Negro / Gris - Yellow / Natural / Black / Grey

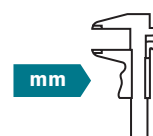

DCTU

Capuchón protector rosca-tubo Protector cap for threads and tubes

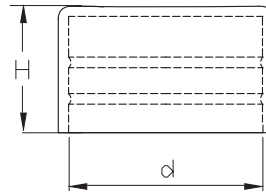

Referencia Reference	d	H	Tamaño tubo /Tube size
			GAS/BSP
01500701135	92,40	24,00	--
01500701136	95,00	34,00	--
01500701137	100,00	40,00	--
01500701138	101,60	42,00	--
01500701139	102,00	40,00	--
01500701140	103,00	39,00	--
01500701141	105,00	39,00	--
01500701142	106,00	40,00	--
01500701143	108,00	38,00	--
01500701144	108,50	90,00	--
01500701145	110,00	38,00	--
01500701146	114,30	38,00	DN100 - 4"
01500701147	114,30	90,00	--
01500701148	116,30	40,00	--
01500701149	117,50	40,00	--
01500701150	121,00	38,00	--
01500701151	125,00	38,00	--
01500701152	126,00	40,00	--
01500701153	127,00	40,00	DN115 - 4 1/2"
01500701154	130,00	40,00	--
01500701155	133,00	40,00	--
01500701156	133,70	90,00	--
01500701157	136,00	40,00	--
01500701158	139,70	38,00	DN125 - 5"
01500701159	141,30	40,00	--
01500701160	146,00	40,00	--
01500701161	149,00	40,00	--
01500701162	151,40	41,50	--
01500701163	152,40	40,00	DN140 - 5 1/2"
01500701164	156,00	40,00	--
01500701165	159,00	37,00	--
01500701166	160,00	40,00	--
01500701167	165,00	65,00	--
01500701168	165,10	40,00	--
01500701169	168,30	36,00	DN150 - 6"
01500701170	168,30	100,00	--
01500701171	176,00	42,50	--
01500701172	177,80	40,00	--

Referencia Reference	d	H	Tamaño tubo /Tube size
			GAS/BSP
01500701173	180,00	39,00	--
01500701174	185,00	41,50	--
01500701175	188,70	100,00	--
01500701176	193,70	42,00	--
01500701177	200,00	38,50	--
01500701178	210,00	35,00	--
01500701179	219,10	42,00	DN200 - 8"
01500701180	225,00	39,00	--
01500701181	232,00	42,00	--
01500701182	242,00	48,00	--
01500701183	244,50	43,00	--
01500701184	250,00	47,00	--
01500701185	267,00	43,00	--
01500701186	273,00	43,00	DN250 - 10"
01500701187	323,90	55,00	DN300 - 12"
01500701188	355,60	57,00	DN350 - 14"
01500701189	368,00	55,00	--
01500701190	400,00	65,00	--
01500701191	406,40	62,00	DN400 - 16"
01500701192	419,00	60,00	--
01500701193	450,00	62,00	--
01500701194	457,20	62,00	DN450 - 18"
01500701195	508,00	67,00	DN500 - 20"
01500701196	558,80	60,00	DN550 - 22"
01500701197	609,60	62,00	DN600 - 24"
01500701198	660,40	115,00	DN650 - 26"
01500701199	711,20	115,00	DN700 - 28"
01500701200	762,00	115,00	DN750 - 30"
01500701201	812,80	115,00	DN800 - 32"
01500701211	863,60	155,00	DN850 - 34"
01500701202	914,40	115,00	DN900 - 36"
01500701203	1.016,00	115,00	DN1000 - 40"
01500701204	1.066,80	115,00	DN1050 - 42"
01500701205	1.117,60	125,00	DN1100 - 44"
01500701206	1.219,20	115,00	DN1200 - 48"
01500701207	1.320,80	150,00	DN1300 - 52"
01500701208	1.422,40	150,00	DN1400 - 56"
01500701209	1.524,00	150,00	DN1500 - 60"
01500701210	1.625,60	150,00	DN1600 - 64"

Color: Amarillo / Natural / Negro / Gris - Yellow / Natural / Black / Grey

Tapones y
Capuchones
Plugs & Caps

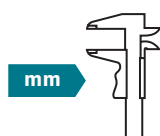

LA Capuchón tubo redondo
Cap for round tube

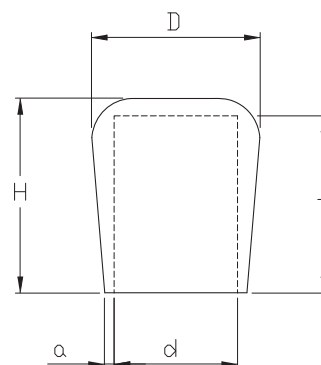

Material: PVC / LDPE+EVA RoHS

Tapones y
Capuchones
Plugs & Caps

Referencia Reference	Para Tubo For tube	d	D	H	T	a
00300700063	1,90	1,90	6,30	10,20	8,50	1,20
00300700064	2,80	2,80	7,60	11,00	9,50	1,50
00300700001	3,00	2,90	5,50	8,80	7,90	0,70
00300700002	3,30	3,20	5,50	8,80	7,60	0,90
00300700065	3,50	3,40	8,30	12,40	9,80	1,50
00300700003	3,50	3,50	5,50	8,80	7,20	0,80
00300700004	4,00	3,90	5,50	8,80	8,00	0,60
00300700066	4,00	3,90	9,20	13,00	9,80	1,70
00300700067	4,80	4,80	11,00	14,00	12,20	1,90
00300700005	5,00	5,00	7,50	8,80	6,70	0,60
00300700068	5,80	5,70	11,10	14,30	12,20	2,00
00300700006	6,00	5,90	7,50	12,00	9,50	0,60
00300700007	6,50	6,40	9,10	10,70	8,00	1,00
00300700008	7,00	6,90	9,10	10,70	8,00	0,80
00300700009	8,00	7,90	11,50	13,00	11,40	0,90
00300700069	8,00	8,00	13,30	17,80	15,00	2,20
00300700010	10,00	9,70	13,40	14,60	12,10	1,20
00300700011	11,00	10,90	15,50	16,00	13,20	1,60
00300700012	12,00	11,90	15,50	16,20	12,90	1,00
00300700013	13,00	12,90	16,50	18,00	14,00	1,30
00300700014	14,00	13,70	17,00	16,00	13,20	1,20
00300700015	15,00	14,80	18,60	17,00	13,40	1,20
00300700016	16,00	15,90	19,70	21,20	17,00	1,10
00300700017	18,00	17,80	22,00	23,20	19,00	1,20
00300700061	18,00	17,80	24,10	25,60	21,80	1,20
00300700018	19,00	18,80	22,30	23,20	9,20	1,30
00300700062	20,00	19,70	26,30	28,40	25,30	1,10
00300700019	20,00	19,80	24,20	23,30	18,90	1,40
00300700020	21,00	21,00	26,40	27,10	21,40	1,40
00300700021	22,00	21,60	27,60	24,10	20,10	1,60
00300700022	24,00	23,70	28,40	27,50	21,10	1,30
00300700023	25,00	24,90	28,10	30,60	24,80	1,30
00300700024	26,00	26,00	32,30	30,00	25,30	1,30
00300700025	27,00	26,50	32,80	30,60	25,40	1,30
00300700026	28,00	27,50	32,80	28,80	23,90	1,50
00300700506	30,00	29,50	33,80	29,20	24,20	--
00300700041	30,00	29,80	34,00	31,10	25,00	2,10
00300700042	32,00	31,80	36,00	30,80	25,50	2,10

Color: Negro / Blanco - Black / White

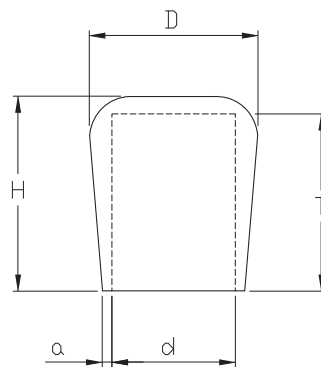

LA
Capuchón tubo redondo
 Cap for round tube

Material: PVC / LDPE+EVA



Referencia Reference	Para Tubo For tube	d	D	H	T	a
00300700043	34,00	33,80	38,00	31,50	24,70	2,00
00300700044	35,00	35,00	39,00	31,20	25,00	2,00
00300700045	38,00	37,90	42,50	33,00	24,00	2,30
00300700046	40,00	39,90	44,50	32,00	26,50	2,30
00300700047	42,00	41,80	46,00	33,00	24,00	2,10
00300700048	43,00	42,80	47,00	32,30	26,30	2,10
00300700049	45,00	44,40	49,00	33,70	25,40	2,30
00300700050	47,00	47,00	51,00	32,00	23,30	2,00
00300700051	48,00	47,90	52,50	32,80	24,80	2,30
00300700052	49,00	48,40	53,00	33,80	27,40	2,30
00300700053	54,00	53,10	57,50	34,30	25,50	2,20
00300700054	59,00	58,80	64,00	37,00	26,80	2,00
00300700055	63,00	63,00	68,00	37,50	27,50	2,50
00300700056	69,00	68,50	73,50	37,50	27,50	2,50
00300700057	75,00	74,60	80,00	40,50	28,00	2,70
00300700058	90,00	89,60	96,00	44,00	31,00	3,20

Color: Negro / Blanco - Black / White

**Tapones y
Capuchones**
 Plugs & Caps

Protectores para bridas de válvulas / Protective valve flange covers

DCTL



DOF



DEF

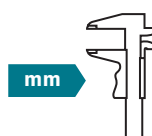

DAF

 Más diseños y medidas disponibles en nuestro catálogo online, consulte en www.isc-sl.com
 More designs and sizes available on our online catalogue, visit www.isc-sl.com

DIF Protector brida
Flange cover

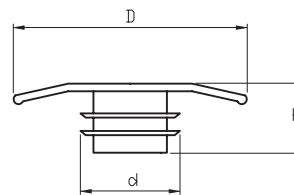

Material: LLDPE

RoHS

Tamaño tubo / Tube size

Referencia Reference	D	d	H	Diá int. brida / Flange in. dia		GAS/BSP
				Máx / Max	Mín / Min	DIN 259 / DIN 2999
01500500001	86,00	14,00	15,00	9,00	13,60	DN 10 - 3/8"
01500500002	90,00	19,00	15,00	13,20	17,30	DN 15 - 1/2"
01500500003	100,00	24,00	20,00	19,50	22,30	DN 20 - 3/4"
01500500004	110,00	30,00	20,00	24,00	28,50	DN 25 - 1"
01500500005	136,00	39,00	20,00	30,00	37,20	DN 32 - 1 1/4"
01500500006	146,00	45,00	20,00	37,80	43,10	DN 40 - 1 1/2"
01500500007	160,00	56,00	20,00	48,00	54,50	DN 50 - 2"
01500500008	180,00	72,00	20,00	63,50	70,30	DN 65 - 2 1/2"
01500500009	196,00	85,00	25,00	76,00	82,50	DN 80 - 3"
01500500010	216,00	109,00	25,00	97,00	107,10	DN 100 - 4"
01500500011	246,00	134,00	25,00	118,00	131,70	DN 125 - 5"
01500500012	280,00	161,00	35,00	148,00	159,30	DN 150 - 6"
01500500013	336,00	210,00	43,00	184,00	208,00	DN 200 - 8"
01500500014	390,00	262,00	41,00	238,00	260,40	DN 250 - 10"
01500500015	450,00	318,00	48,00	285,00	315,00	DN 300 - 12"
01500500016	580,00	410,00	62,00	355,00	408,00	DN 400 - 16"

Tapones y
Capuchones
Plugs & Caps

Color: Amarillo - Yellow

PARA ROSCAS/FOR THREADS														
Referencia Reference	DIN 2627 - 26 38							ANSI B 16.5						
	BS 4504							BS 1560						
	PN 10-16	PN 25-40	PN 64	PN 100	PN 160	PN 250	PN 300	PN 400	Cl. 150-300	Cl. 400	Cl. 600	Cl. 900	Cl. 1500	Cl. 2500
01500500001														
01500500002														
01500500003														
01500500004														
01500500005														
01500500006														
01500500007														
01500500008														
01500500009														
01500500010														
01500500011														
01500500012														
01500500013														
01500500014														
01500500015														
01500500016														

mm



PTFA

Capuchón protector Protector cap

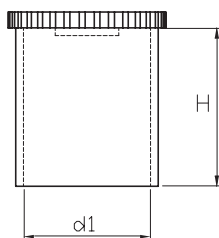

Material: LLDPE

Referencia Reference	d1	H
01500701307	8,00	10,00
01500701308	10,00	10,00
01500701309	10,00	28,00
01500701310	12,00	16,00
01500701311	14,00	15,00
01500701312	16,00	15,00
01500701313	16,00	20,00
01500701314	18,00	20,00
01500701315	20,00	20,00
01500701316	22,00	18,00
01500701317	26,00	31,00
01500701318	27,00	20,00
01500701319	30,00	31,00
01500701320	33,00	25,00
01500701321	35,00	33,00
01500701322	40,00	27,00

Color: Natural - Natural

LSEK

Cantoneira esquina Corner protector cap

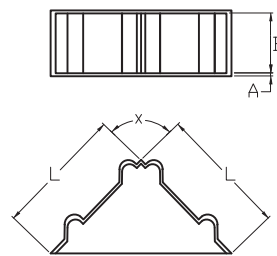
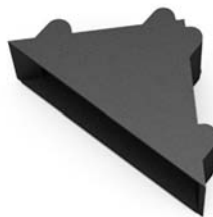

Material: LDPE

Referencia Reference	G. Panel (B) P. Thickness (B)	L	Ángulo (X) Angle (X)	A
00300700507	2,00 - 3,00	50,00	90°	1,00
00300700508	3,00 - 4,00	50,00	90°	1,00
00301200731	3,00 - 4,00	50,00	90°	1,00
00301200732	4,00 - 5,00	50,00	90°	1,00
00301200733	5,00 - 6,00	50,00	90°	1,00
00301200734	7,00 - 8,00	50,00	90°	1,00
00301200735	9,00 - 10,00	50,00	90°	1,00
00301200736	15,00 - 16,00	50,00	90°	1,00
00301200737	19,00 - 20,00	50,00	90°	1,00
00301200738	21,00 - 22,00	50,00	90°	1,00
00301200739	25,00 - 26,00	50,00	90°	1,00
00301200742	28,50 - 30,00	50,00	90°	1,00
00301200741	32,00 - 33,00	50,00	90°	1,00
00301200740	39,00 - 40,00	50,00	90°	1,00
00301201457	49,00 - 50,00	50,00	90°	1,00

Color: Negro - Black

LSEO

Cantoneira esquina Corner protector cap

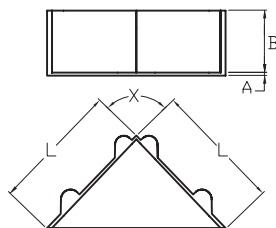

Material: LDPE

Referencia Reference	G. Panel (B) P. Thickness (B)	L	Ángulo (X) Angle (X)	A
00300601628	25,00	50,00	90°	1,00

Color: Negro - Black

LUD

Protector perfil angular Angular protector profile

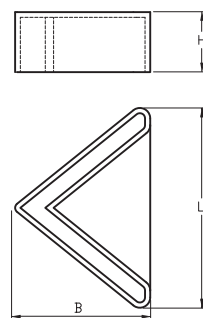

Material: LDPE

Referencia Reference	Perfil Profile	G. Panel P. Thickness	L	B	H
00300700088	25x25	1,50 - 2,00	42,60	26,60	11,50
00300700089	30x30	1,00 - 2,50	37,40	27,50	10,00
00300700090	36x36	1,50 - 2,50	58,50	34,60	11,30
00300700091	40x40	1,50 - 3,00	62,90	36,20	12,00

Color: Negro - Black